



USER'S MANUAL



BATTERY HV

HV Smart 5K



ZUCCHETTI
Centro Sistemi



GREEN
INNOVATION

IMPORTANT COMMUNICATION

Inside the box of this product is available the manual in English. Please note that more up-to-date revisions of the supplied manual may be available. Therefore, in order to ensure the correct installation and maintenance procedure it is necessary to verify the manuals, available in all languages, within the documentation or products section of the www.zcsazzurro.com website, the same documentation is also available by scanning the qr code on the front of the product or directly within the app Azzurro Operators.

Datasheets, technical notes, certifications and warranty terms and conditions are also available on the above platforms.

Battery

AZZURRO HV Smart 5K

User Manual



Table of Contents

General information	6
1.1. Product Model Description	6
1.2. Validity	6
1.3. Intended Use.....	6
1.4. Identifying The Product.....	7
Preface.....	9
2.1. Symbols Used in the Manual.....	9
Product Notice	10
3.1. Requirement for Installation, Operation and Maintenance.....	10
3.2. Description of symbols on the product.....	15
Product Introduction	16
4.1. Product Function Introduction.....	16
4.2. Product application system diagram	17
4.3. Product Appearance Description.....	18
4.3.1. BDU.....	18
4.3.2. Battery module.....	21
4.3.3. Base	22
Equipment Inspection	23
5.1. Inspection before Signing	23
5.2. Checking packing list	23
Installation	25
6.1. Installation Requirements.....	25
6.1.1. Installation Environment.....	25
6.2. Installation Space Requirement.....	26
6.3. Installation Tools	26
6.4. Moving the Product	28
6.5. Product Installing.....	28
6.5.1. Base installation.....	29
6.5.2. Installing the battery module.....	30

6.5.3. Installing and Fixing the BDU.....	31
Electrical Connection.....	32
System operation.....	34
7.1. Check before power on	34
7.2. Power-on.....	34
7.3. Power-off.....	34
Light indicator.....	35
8.1. The Product indicator light	35
8.2. BDU indicator light	35
8.3. Battery module indicator light	36
8.4. Description of Product Status abbreviation.....	38
Product Storage and Daily Maintenance.....	39
9.1. Product storage	39
9.2. Maintenance	39
9.2.1. Regular Maintenance	39
9.2.2. Daily Maintenance.....	41
9.2.3. System expansion and replace of battery modules.....	41
9.2.4. Troubleshooting.....	42
Connect X APP.....	46
10.1. Overview	46
10.2. Download and install APP (Customer & Installer).....	46
10.3. Apply for an account (Installer)	47
10.4. Register account (Customer).....	47
10.5. Create Stations and bind devices (Installer).....	48
10.6. Configure WiFi (Customer & Installer)	49
Technical Parameters.....	50
Disposal	51
Warranty terms and conditions	51



General instructions

This manual contains important safety instructions that must be followed during installation and maintenance of the equipment.

Please keep these instructions!

This manual must be considered an integral part of the equipment, and must be available at all times to everyone who interacts with the equipment. The manual must always accompany the equipment, even when it is transferred to another user or plant.

Copyright statement

Copyright of this manual belongs to Zucchetti Centro Sistemi S.p.A. No part of this manual (including the software, etc.) may be copied, reproduced or distributed in any form or by any means without the permission of Zucchetti Centro Sistemi S.p.A. All rights reserved. ZCS reserves the right to final interpretation. This manual is subject to change based on feedback from users, installers or customers.

Please check our website at <http://www.zcsazzurro.com> for the latest version.

Technical support

ZCS offers a support and technical consultancy service accessible by sending a request directly from the website <https://www.zcsazzurro.com/it/support>.

The following toll-free number is available for the Italian territory: 800 72 74 64.



General information

This manual introduces AZZURRO HV Smart 5K Battery. Please read this manual before you use the battery. Any confusion, please contact AZURRO technical support immediately for advice and clarification. This Manual mainly introduces the product information, installation, electrical connection, configuration commissioning and maintenance, and technical parameters of X-OHM pro series product. Before installing and using this product, please read this Manual carefully to understand the safety information and be familiar with the functions and features of the product. This document is intended for professional electrical engineers who are responsible for battery installation and commissioning, including technical support engineers, system engineers, and electrical engineers. This manual may be updated in the future. Please obtain the latest version from the official website to get more product information.

1.1. Product Model Description

This document applies to AZZURRO HV Smart 5K. The product provides stable power supply paired with inverter and is suitable for use in public places such as homes, schools, shopping malls, or hospital.

1.2. Validity

This user manual is applicable to AZZURRO HV Smart 5K Battery. This user manual contains AZZURRO HV Smart 5K product information, usage guidance, safety information, installation guide and details on common operating issues and subsequent corrective actions.

1.3. Intended Use

This Manual is only suitable for professional technicians who are familiar with local regulations, standards and electrical systems, have received professional training, and are familiar with the relevant knowledge of this product.

AZZURRO HV Smart 5K is an energy storage unit that is designed to be used in residential on-grid applications with the capability for short-term backup.

Notes regarding intended use:

AZZURRO HV Smart 5K is not suitable for supporting life-sustaining medical devices.

This product is intended for use only in accordance with the information provided in the enclosed documentation and with the locally applicable standards and regulations. Any other application may cause personal injury or property damage.

The illustrations in this manual are meant only to help explain system configuration concepts, includes usage guidance, safety precautions, and common operating issues and subsequent corrective actions.

Alterations to the product, e.g. changes or modifications, are only permitted with the express written permission of ZCS Technical Support. Unauthorized alterations will void warranty claims. Zucchetti Centro Sistemi S.p.A. shall not be held liable for any damage caused by such changes. Any use of the product other than that described in the Intended Use section does not qualify as appropriate. The enclosed documentation is an integral part of this product. Keep the documentation in a convenient place for future reference and observe all instructions contained therein. The type label must remain attached to the product.

Please contact ZCS Technical Support or local after-service providers within 1 week once the user decides to cease using their ZCS Battery products.

1.4. Identifying The Product

The type labels were attached on the product, which contain the product identification information. For safe usage, the user must be well-informed of the contents in the type labels.

The type labels include:



 Rechargeable Lithium Iron Phosphate Battery System IFP/27/175/200/[(1P16S)-P]E/20+50/96	
Model:	BDU Smart 5K
Nominal Voltage:	400V
Operating Voltage:	330V~450V
Operating Ambient Temp. :	Charge: -15°C~50°C Discharge: -20°C~50°C
Max. Charge / Discharge Current / Power:	Charge: 50.0A/20.0kW Discharge: 50.0A/20.0kW
Ingress Protection:	IP65
Weight:	10 kg
Model / Nominal Energy / Max. Charge Power / Max. Charge Current / Max. Discharge Power / Max. Discharge Current / WiFi	
<input type="checkbox"/> HV Smart 5K-1P15.12kWh/2.5kW/6.3A/5.0kW/12.5A/WiFi	
<input type="checkbox"/> HV Smart 5K-2P16.24kWh/5.0kW/12.5A/10.0kW/25.0A/WiFi	
<input type="checkbox"/> HV Smart 5K-3P18.36kWh/7.5kW/18.8A/15.0kW/37.5A/WiFi	
<input type="checkbox"/> HV Smart 5K-4P20.48kWh/10.0kW/25.0A/20.0kW/50.0A/WiFi	
<input type="checkbox"/> HV Smart 5K-5P25.60kWh/12.5kW/31.3A/20.0kW/50.0A/WiFi	
<input type="checkbox"/> HV Smart 5K-6P36.72kWh/15.0kW/37.5A/20.0kW/50.0A/WiFi	
<input type="checkbox"/> HV Smart 5K-7P35.84kWh/17.5kW/43.8A/20.0kW/50.0A/WiFi	
<input type="checkbox"/> HV Smart 5K-8P40.96kWh/20.0kW/50.0A/20.0kW/50.0A/WiFi	
<ul style="list-style-type: none"> *Do not drop, deform, impact, cut or spear with sharp objects. *Do not place near open flame or flammable materials. *Do not cover or wrap the product case. *Do not come into contact with liquids. *Avoid direct sunlight and be aware of high temperature. *If any leakage, fire, wet or damage occur, switch off the breaker on DC side and stay away from the battery. *Contact the supplier within 24 hours if failure occurs. 	
	
	
<div style="border: 1px dashed black; width: 100%; height: 100%;"></div>	
Zucchetti Centro Sistemi SpA. Made in EXTRA EU Via Lungarno 305 52028 Terranuova Bracciolini (AR), Italy	

Figure 1 – Labels on the side of the battery





Rechargeable Lithium Iron Phosphate Battery IFpP/27/175/200[1P16S]E/-20+50/95	
Name:	ZCS Azzurro
Model:	HV Smart 5K
Nominal Capacity/Energy:	100Ah / 5120Wh
Battery Type:	LiFePO ₄
Nominal Voltage:	400V
Operating Voltage:	330V~450V
Operating Ambient Temp.:	Charge: -15°C~50°C Discharge: -20°C~50°C
Max.Charge Current / Power:	6.3A / 2500W
Max.Discharge Current / Power:	12.5A / 5000W
Protective Class:	I
Ingress Protection:	IP65
Weight:	50kg
Function:	<input checked="" type="checkbox"/> Heating <input checked="" type="checkbox"/> Firefighting
<p>•Do not touch the radiating fins on back of the shell, avoiding heat burns.</p> <p>•Do not disconnect or disassemble by nonprofessional personnel.</p> <p>•Do not drop, deform, impact, cut or spear with sharp objects.</p> <p>•Do not place near open flame or flammable materials.</p> <p>•Do not cover or wrap the product case.</p> <p>•Do not come into contact with liquids.</p> <p>•Avoid direct sunlight and be aware of high temperature.</p> <p>•If any leakage, fire, wet or damage occur, switch off the breaker on DC side and stay away from the battery.</p> <p>•Contact the supplier within 24 hours if failure occurs.</p>	
<div style="border: 1px dashed black; height: 60px; width: 100%;"></div>	
<p>Zucchetti Centro Sistemi SpA. Made in EXTRA EU Via Lungarno 305 52028 Terranuova Bracciolini (AR), Italy</p>	





Figure 2 – Labels on the side of the battery



Preface

2.1. Symbols Used in the Manual

In order to ensure the user's personal and property safety when using the Product, and to use the product efficiently, relevant safety operation information is provided in this Manual and highlighted with corresponding symbols. Please fully understand and strictly abide by below emphasized information to avoid personal injury and property damage. The symbols used in this manual are listed below.

 Danger	<p>It indicates a highly potential hazard which, if not avoided, will result in death or serious injury.</p>
 Warning	<p>It indicates a hazard with a medium level of potential which, if not avoided, could result in death or serious injury.</p>
 Caution	<p>It indicates a hazard with a low level of potential which, if not avoided, could result in moderate or minor injury.</p>
 Attention	<p>It indicates a potential hazard which, if not avoided, could result in the equipment malfunction or property damage.</p>
 Note	<p>It indicates the emphasis and supplementary instructions on the content, and may also provide tips for optimizing the product use, which can help you solve a certain problem or save your time.</p>



Product Notice

The safety precautions information contained in this document must always be followed when operating the equipment.

It is important and necessary to read the user manual carefully (and attachment) before installing or using battery. Failure to do so or to follow any instruction or warning in this document can result in electrical shock, serious injury, and death, or damage product, potentially rendering it unusable.

All operations of the equipment must be carried out by professional electrical technicians, and the technicians need to be familiar with the relevant standards and safety regulations of the project location.

3.1. Requirement for Installation, Operation and Maintenance



 	<ul style="list-style-type: none"> ✓ When operating the product, use insulated tools and wear personal protective equipment to ensure personal safety. When touching electronic devices, wear ESD gloves, ESD wrist straps, and ESD clothing to prevent the inverter from being damaged by static electricity and causing losses. ✓ The installation onsite shall be equipped with fire-fighting facilities that meet relevant requirements, such as fire sand, dry powder fire extinguisher, etc. ✓ Machine damage or personal injury caused by installation, use, and configuration not in accordance with the requirements of this Manual is not within the scope of the equipment manufacturer's responsibility. ✓ Do not open, repair or disassemble the battery except ZCS personnel or other authorized personnel. The company shall not bear any liability or responsibility caused by violation of any safety operation or design standard, production standard, equipment safety standards or any other standards or requirements.
---	--





Warning

- ✓ Please carefully read the content about battery safety introduced in the Manual before installing the equipment, and operate in strict accordance with the requirements in the Manual.
- ✓ Do not use any liquid to clean the battery.
- ✓ Do not expose battery to flammable or irritating chemicals or vapor.
- ✓ Do not paint any part of battery, including any internal or external components.
- ✓ It is prohibited to connect the battery and AC power directly.
- ✓ Wiring must be correct, do not misconnect the positive and negative cables, and ensure no short circuit with the external device.
- ✓ The battery is designed in parallel, please DO NOT connect battery in series.
- ✓ Do not connect the same battery pack to other inverters, or the inverter will be damaged.
- ✓ If the battery fails to start, please contact the after-sales service center as soon as possible. Otherwise, the battery may be permanently damaged.
- ✓ Direct or indirect damages caused by non-standard operation are not covered by warranty claims.
- ✓ If the battery pack leaks electrolyte, avoid contact with the leaking liquid or gas. If one is exposed to the leaked substance, immediately perform the actions described below.
 - Inhalation: Evacuate contaminated area and seek medical attention.
 - Contact with eyes: Rinse eyes with flowing water for 15 minutes and seek medical attention.
 - Contact with skin: Wash affected area thoroughly with soap water and seek medical attention.
 - Ingestion: Induce vomiting and seek medical attention.

 <p>Warning</p>	<ul style="list-style-type: none"> ✓ In case of fire, only dry powder fire extinguisher can be used, liquid fire extinguishers are prohibited. ✓ If the module is wet or submerged in water, do not let people access it, then contact ZCS or an authorized dealer for technical support. Cut off all power switch on inverter side. ✓ Please ensure that the frame of the module and the bracket system are properly grounded. ✓ After the DC cable is connected, please ensure that the cable connection is tight and firm. ✓ Please use the DC terminals provided with the box to connect the DC cables of the inverter. If other types of DC terminals are used, serious consequences may result, and the manufacturer isn't responsible for equipment damage therefrom.
 <p>Danger</p>	<ul style="list-style-type: none"> ✓ There is high voltage during the operation of the product. If you need to operate the product, please ensure that the product is powered off. ✓ The casing of the product is very hot when it is running. Do not touch it, or it may cause burns. ✓ After the product is powered off for a period of time, the internal capacitor is still charged. Please wait for more than 5 minutes until the capacitor is completely discharged. ✓ When the product is running, some components may be electrified or hot. Improper use, incorrect installation or operation may result in serious personal or property injury. Transport, installation, disassembly, start-up and maintenance operations must be performed by qualified electrical engineers. ✓ If product needs to be moved or repaired, power must be cut off and battery is completely shut down. ✓ Damaged batteries may leak electrolyte or produce flammable gas, and must be handled with utmost care. They are not fit for use and may pose a danger to people or property. If the module seems to be damaged, pack it in its original container, then return it to authorized dealer.
 <p>Note</p>	<ul style="list-style-type: none"> ✓ If the battery has been fully discharged, please charge the battery strictly according to the corresponding type of battery in the Manual. ✓ The battery current is affected by Depend on the temperature and SOC of battery, which may cause the battery current limit and affect the inverter load performance.

The installation of battery intelligent battery system must be in full compliance with national and local laws and regulations.

Read and understand all instructions contained in this manual and familiarize yourself with safety symbols before installing and commissioning the device.

For any maintenance or repair, please contact the nearest authorized repair center. For information about the nearest authorization center, contact your reseller. Do not repair by yourself, which may cause personal injury or property injury.

Before installing and maintaining the device, disconnect the device from the external device using the DC switch. Otherwise, the high voltage may cause serious injury.

AZZURRO ZCS will not be responsible for any personal injury or property injury caused by improper use.

Installation and maintenance personnel requirements

The personnel responsible for installation and maintenance of the equipment for the first voyage must first receive strict training, understand various safety precautions and master correct operation methods.

- ✓ Only qualified professionals or trained personnel are allowed to install, operate, and maintain the device.
- ✓ Only qualified professionals are allowed to remove safety facilities and repair devices.
- ✓ The personnel, including the operators, trained personnel, and professional personnel, who operate the equipment should have the special operation qualification required by the local state, such as the qualification of high voltage operation, height climbing, and special equipment operation.
- ✓ Only professional or authorized personnel can replace equipment or components (including software).

Note :

- ✓ Professional personnel: those who have the training or operation experience of equipment and are able to understand the potential sources and magnitude of hazards in the process of equipment installation, operation and maintenance.
- ✓ Trained personnel: personnel who have received the appropriate technical training and have the necessary experience are aware of the risks that may be posed to them in performing a certain operation and can take measures to minimize the risks to themselves or other personnel.
- ✓ Operators: operators who may have access to the equipment except trained and professional personnel.

Transportation Requirement

The Batteries are in the good electrical and physical condition when it ship out from factory. During transport, battery module must be placed in its original package or other proper package. Transportation company should responsible for any damage during transport period. Please check the battery thoroughly when taking delivery. If you find any packing problems that may cause the damage of inverter or any visible damage, please notice the responsible transportation company immediately. You can ask your installer or AZZURRO ZCS for help is necessary.

This product contains battery module through UN38.3, belongs to the ninth category of dangerous goods. Therefore, loading and unloading must comply with local laws and regulations and industry standards during

transportation. Rough loading and unloading may cause short circuit or damage to batteries in containers, which may result in battery leakage, breakage, explosion, or fire.





Requirement During the Transportation

- ✓ Shipping complies with the IMDG CODE and the International Maritime Dangerous Goods CODE.
- ✓ For land transportation, comply with ADR or JT T617 shipping requirements
- ✓ Meet the regulatory requirements of the transport regulatory authorities of the country of origin, route and destination.
- ✓ Comply with international regulations for the transport of dangerous goods and the supervision requirements of the corresponding national transport regulatory authorities.



3.2. Description of symbols on the product

There are some safety-related labels on the residential Energy Storage System. Please carefully read and fully understand the content of these labels before installing the product.

Symbol	Description	Meaning
	Ground terminal	Connect the product to the ground to achieve the purpose of ground protection.
	Read the Manual	Before installing the Product, please carefully read and understand this Manual.
	Certification	The product meets CE certification.
	Recycle and Dispose	In case a battery (normal condition or damaged) needs disposal or needs recycling, it shall follow the local recycling regulation to process, and using the best available techniques to achieve a relevant recycling efficiency.
	Recycle and Dispose	Label for Waste Electrical and Electronic Equipment (WEEE). Directive (2012/19/EU).



Product Introduction

4.1. Product Function Introduction

The AZZURRO HV Smart 5K includes BDU, battery module and base, supporting up to 8 modules expansions, and 2 BDU can be interconnected through communication cables.

The power ranges start from minimum 5kWh up to maximum 80kWh.

The system adopts a modular design and stacked installation method which greatly reduces wiring and installation costs.

In the period of rising energy costs such as oil and coal, the declining energy subsidies of PV grid-connected systems, mountainous areas without grids or base stations with uninterrupted power supply and emergency power supply needs, the product can provide a complete solution.

The AZZURRO HV Smart 5K has “4S” characteristics, realize maximum energy optimization of battery modules by built-in DC-DC, used in many occasions such as residential and commercial applications.

※ **Safe**

Extreme BMS strategy

Modular fire protection

Complete protection circuit

※ **Simple**

Building stack installation

Without wire connection

10 minutes installation (15kWh)

installation time

※ **Smart**

7*24 hours online monitoring

One click power on and off

Remote maintenance and upgrades

※ **Suitability**

Suitable for mixing old and

new batteries

Compatible with mainstream

HV inverters

4.2. Product application system diagram

The system includes 1 PCS and 1 BDU unit, and can expand up to 8 battery modules.

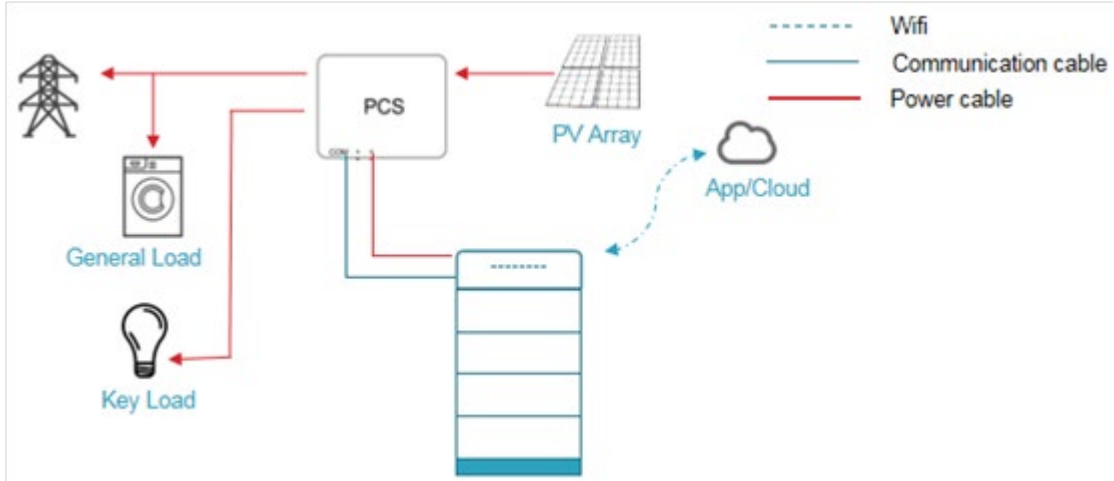

Figure 3 - Single string system diagram

The system includes 1 PCS and 2 BDU unit, and can expand up to 16 battery modules.

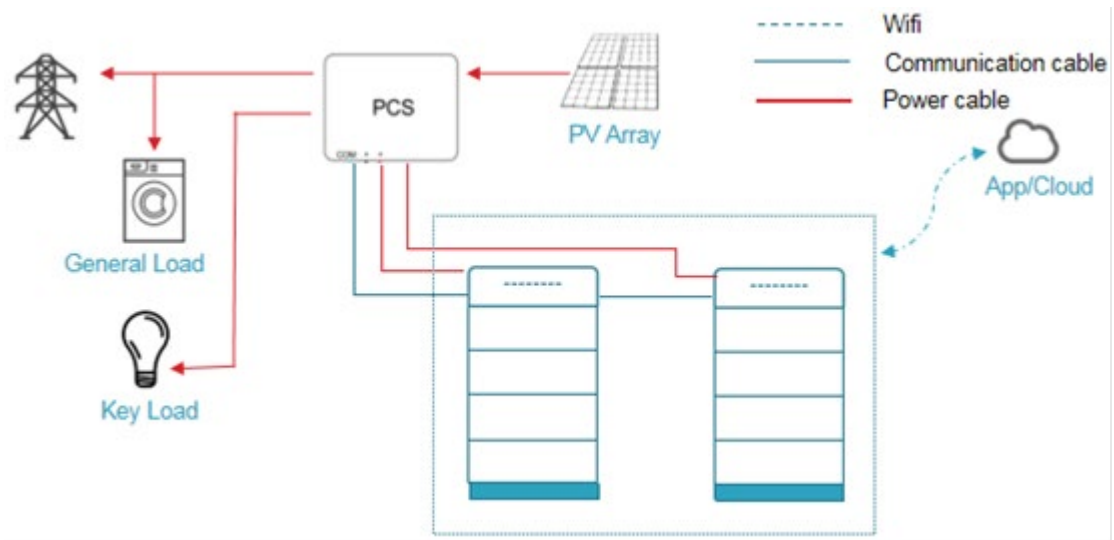
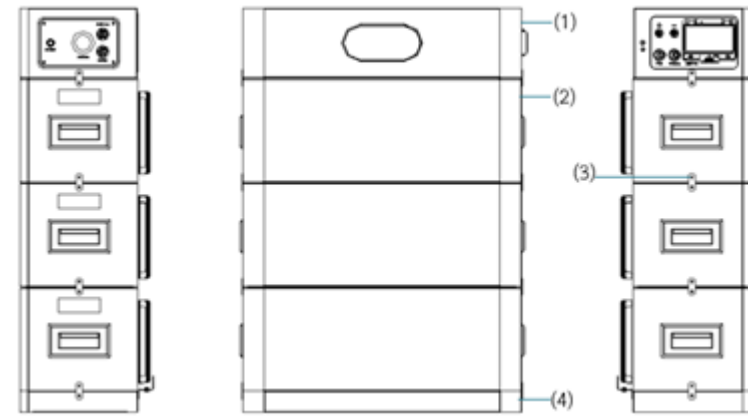

Figure 4 - Parallel connection system diagram



4.3. Product Appearance Description

The following diagram shows the product composition using 15kwh system.



Symbol	Component	Symbol	Component
(1)	BDU	(3)	Fixed bracket
(2)	Battery module	(4)	Base

Table 1 – System component name

4.3.1.BDU

(1) As the unit that interacts with the inverter in the energy storage system, it integrates functions such as power control, communication, system status indication, and safety protection. The product can effectively disconnect the power circuit with the inverter through the breaker, and can be remotely upgraded through the built-in wireless upgrade unit.

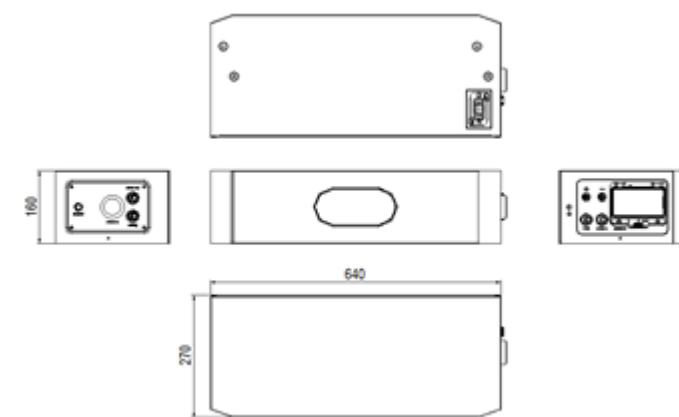

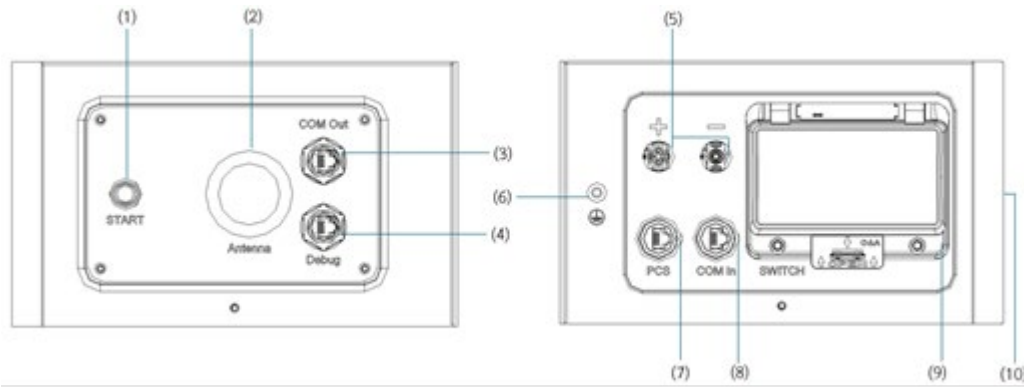

Symbol	Component	Symbol	Component
1	Start button	6	Grounding point
2	Antenna	7	Inverter communication port
3	Communication port: COM Out	8	Communication port: COM In
4	Debug port	9	DC breaker
5	Power terminals: +/-	10	System indicator panel

Table 2 - BDU component name

(2) The port pins of the BDU are defined as follows:

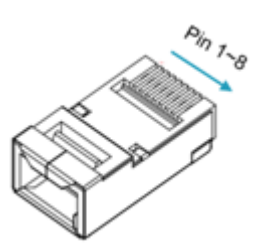

Figure 1 - RJ45 Poert Pin Definition

PCS

Pin	Definition	Pin	Definition
1	DI1+	5	CAN_L
2	DI1-	6	/
3	/	7	/
4	CAN_H	8	SGND

Table 3 - PCS Port Pins Definition

DEBUG

Pin	Definition	Pin	Definition
1	RS485_B	5	CAN_L
2	RS485_A	6	/
3	/	7	/
4	CAN_H	8	/

Table 4 - Debug Port Pins Definition

COM In

Pin	Definition	Pin	Definition
1	DI1+	5	RS485_A
2	DI1-	6	RS485_B
3	RS485_A	7	CAN_L
4	RS485_B	8	CAN_H

Table 5 –COM In Port Pins Definition

COM Out

Pin	Definition	Pin	Definition
1	DO1+	5	RS485_A
2	DO1-	6	RS485_B
3	RS485_A	7	CAN_L
4	RS485_B	8	CAN_H

Table 6 –COM Out Port Pins Definition



4.3.2. Battery module

The battery module integrates long cycle life battery cells, DCDC+BMS, fire protection (optional) and heating (optional), and the module is designed with separate compartments inside. The module supports a maximum of 2.5kw charging and 5kw discharging power. When expanding the battery capacity, it can be simply stacked without additional wiring.

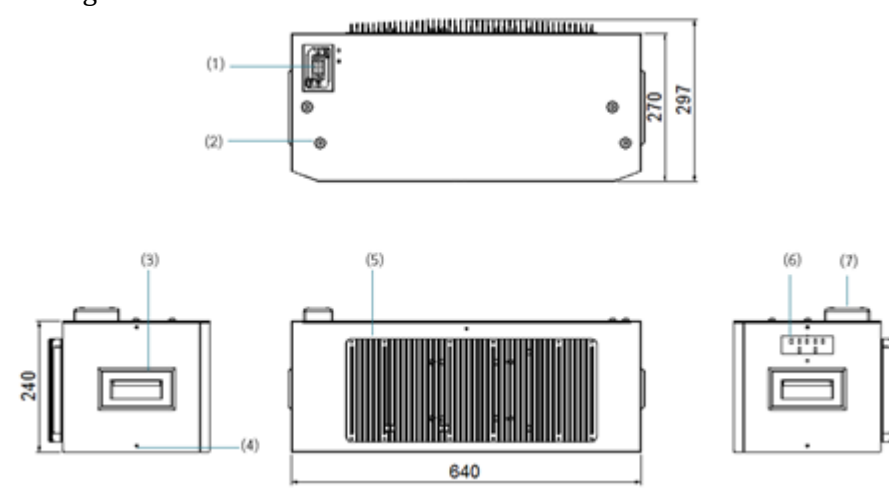

Symbol	Component	Symbol	Component
(1)	Bottom connector	(5)	radiator
(2)	Positioning pin	(6)	Battery module Indicator panel
(3)	handle	(7)	Top connector
(4)	Battery module fixing hole		

Table 7 - Battery Module component name



4.3.3.Base

Each energy storage system includes one base, which is used for fixation and protection purposes. When installing the product, please make sure to install the base to avoid accidents caused by the power connectors on the bottom outlet of the battery module.

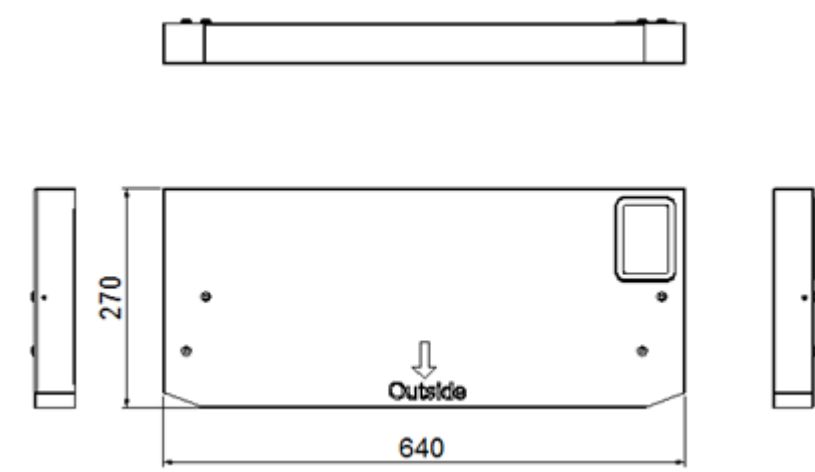







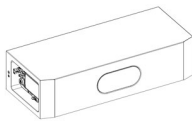

Equipment Inspection

5.1. Inspection before Signing

Before signing for the product, please check the following in detail:

- ✓ Check whether the outer package is damaged, such as holes, deformation, cracks or other signs that may cause damage to the equipment in the box. If there is any damage, do not open the package and contact your dealer.
- ✓ Check whether the BDU (Battery distribution unit) and battery model is correct; if not, do not open the package and contact your dealer.
- ✓ Check whether the type and quantity of deliverables are correct, and whether the appearance is damaged. In case of damage, please contact your dealer.

5.2. Checking packing list

No	Pictures	Description	Quantity
1		Battery distribution unit (BDU)	1pcs
2		Base	1pcs
3		Positive power cable (Maximum continuous passing current 35A)	1pcs
4		Negative power cable (Maximum continuous passing current 35A)	1pcs
5		Grounding cable	1pcs
6		Screw M4*12	4pcs
7		Communication cable to PCS	1pcs
8		Parallel communication cable	1pcs
9		Side fixing bracket	2pcs



10		Back fixing bracket	1pcs
11		User Manual	1pcs

Table 8 -Components and mechanical parts to be delivered for BDU





No	Pictures	Description	Quantity
1		Battery module	1pcs
2		Back fixing bracket	1pcs
3		Side fixed bracket	2pcs
4		M6 plastic expansion pipe and screw	2pcs
5		M4x12 bolt	2pcs

Table 9 -Components and mechanical parts to be delivered for battery modules

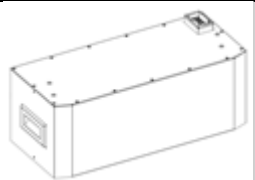

Installation

6.1. Installation Requirements

6.1.1. Installation Environment

- 1) Do not install the equipment in flammable, explosive or corrosive environments.
- 2) Please keep away from the water pipes and cables in the wall at the installation location to avoid danger when drilling holes.
- 3) The installation location should be kept out of the reach of children, and should not be installed in places that are easy to touch. The surface may be hot when the equipment is in operation. Be careful to prevent burns.
- 4) The installation environments of inverter need to avoid direct sunlight, rain and snow. It is recommended to install it in a sheltered installation location. If necessary, a sunshade can be built.
- 5) The installation space must meet the equipment ventilation and heat dissipation requirements and operating space requirements.
- 6) The protection level of the equipment meets indoor and outdoor installation, and the temperature and humidity of the installation environment must be within the appropriate range of the product specification. The ambient temperature: $-10^{\circ}\text{C} \sim 45^{\circ}\text{C}$ and the Relative humidity: 5-85% (non-condensing).
- 7) Please ensure that the indicator lights and all labels of the equipment are easily visible and the terminal blocks are easily accessible.
- 8) The product must be installed in a dust-free environment to avoid dust accumulation and reduce the effective heat dissipation of the product radiator.
- 9) Keep away from strong magnetic field environment to avoid electromagnetic interference.
- 10) The installation carrier must not be a flammable material and must have fire resistance.

The product has an IP65 degree of protection, a parameter defined by the international standard IEC 60529. This standard assesses the effectiveness of electrical enclosures in protecting against intrusion of objects, water, dust and accidental contacts.

For this product, specifically results:

- ✓ Completely airtight with dust and fumes.
- ✓ Protected against water jets coming from any direction.

To ensure consistent performance over time, avoid exposing the product to extreme temperatures and adverse weather conditions. Always ensure that the installation environment meets the technical specifications set out in this manual.

6.2. Installation Space Requirement

- 1) The installation involves vertically stacking batteries and BDU.
- 2) The product must be wall mounted using the appropriate fixings.
- 3) Do not install the product at forward tilted, side tilted, horizontal, or upside down positions.
- 4) Reserve sufficient clearance around the product to ensure sufficient space for installation, maintenance and heat dissipation.

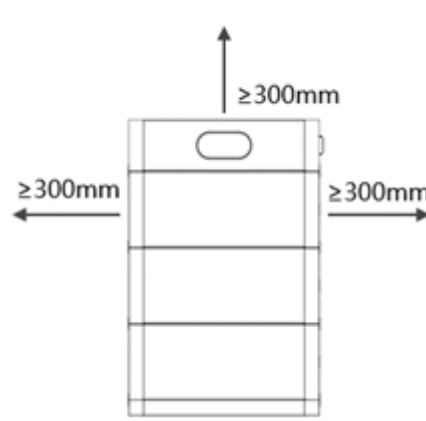

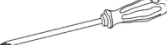

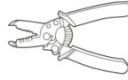





Figure 5 - Installation space diagram

6.3. Installation Tools

Prepare tools for installation and electrical connections.

NO	Tool	Model	Function
1		Electric drill	Used to drill holes on the wall.
2		6mm Screwdriver	Remove and install screws and wires
3		4mm Screwdriver	Remove and install screws and wires
4		Cable stripper	Used to peel cable
5		Socket wrench	Remove and install screws and wires
6		Multi meter	Check whether the cable connection is correct, the positive and negative terminals of the battery are correct, and the grounding is reliable
7		Marker	Mark signs







8		Measuring tape	Measure distance
9		Level	Ensure the rear panel is properly installed
10		Rubber hammer	
11		ESD gloves	Installer wear when installing product
12		Safety goggles	Installer wear when drill holes
13		Mask	Installer wear when drill holes

Table 10 - Tools required for installation and electrical connections

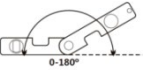

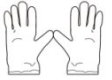
6.4. Moving the Product

Take the product out of the package and move it horizontally to the designated installation location. Open the outer packing box, two operators respectively put their hands under the BDU, or Thread the two fixing holes of the handle through the locating pins on the battery cover, move the product out of the outer packing box, and move it to the designated installation location.

 <p>Attention</p>	<ul style="list-style-type: none"> ✓ When carrying out operations such as transportation, turnover, and installation, the laws, regulations, and relevant standards of the country and region where it is located must be met. ✓ Please note during transportation that the radiator of the battery module cannot withstand gravity. ✓ When the product is placed on the ground, place foam or cardboard under it to avoid damage to the casing. ✓ At least two persons are required to install battery modules.
 <p>Danger</p>	<ul style="list-style-type: none"> ✓ Since the product is heavy, please keep the balance when carrying it, so as not to hurt the operators when the machine falls. ✓ During the transportation process, please wear protective shoes and gloves, etc.

6.5. Product Installing

 <p>Attention</p>	<ul style="list-style-type: none"> ✓ Before installing and maintaining the device, disconnect the device from the external device using the DC switch. Otherwise, the high voltage may cause serious injury. ✓ When drilling, ensure that the drilling position avoids water pipes and cables in the wall to avoid danger. ✓ When punching holes, please wear goggles and dust mask to prevent dust from being inhaled into the respiratory tract or falling into the eyes.
---	--

6.5.1. Base installation

- 1) Fix the bracket to the back of the base with M4 bolts.
- 2) Place the base on the wall so that the bracket is closed to the wall.
- 3) Mark on the wall through any installation hole on the back fixing bracket.
- 4) Remove the base, drill a hole with a diameter of 10mm and a depth of 50-70mm using an electric drill, and then use rubber hammer to tap in the plastic expansion pipe.
- 5) Place the base back in place and tighten the back fixing bracket with M6 self tapping screws.

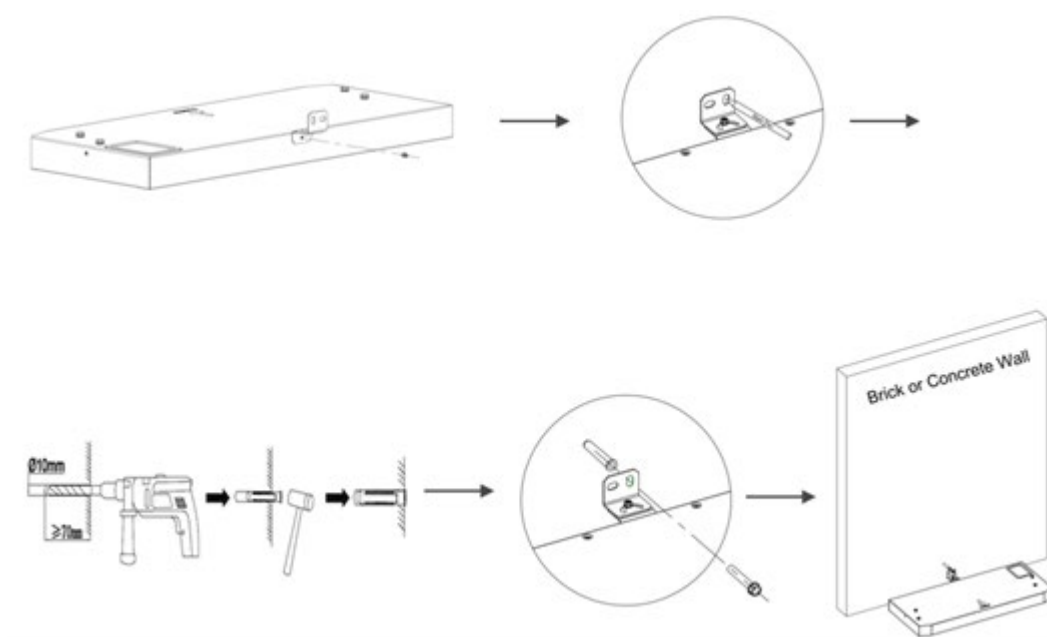

Figure 6 - Base installation diagram

6.5.2. Installing the battery module

- 1) Fix the bracket with M4 bolts to the back of the top battery and this battery module is placed at the top.
- 2) Two people grab the handle of battery module and move it above the base slowly.
- 3) Continue to place the second battery module and until the last battery module with the back bracket is stacked.
- 4) Adjust the back bracket of the topmost battery module to make it tightly adhere to the wall.
- 5) Select any installation hole on the bracket and mark it, then remove the battery pack and drill a hole.
- 6) Install the plastic expansion tube in the installation hole and replace the battery pack, and secure the back bracket with M6 self tapping screws.

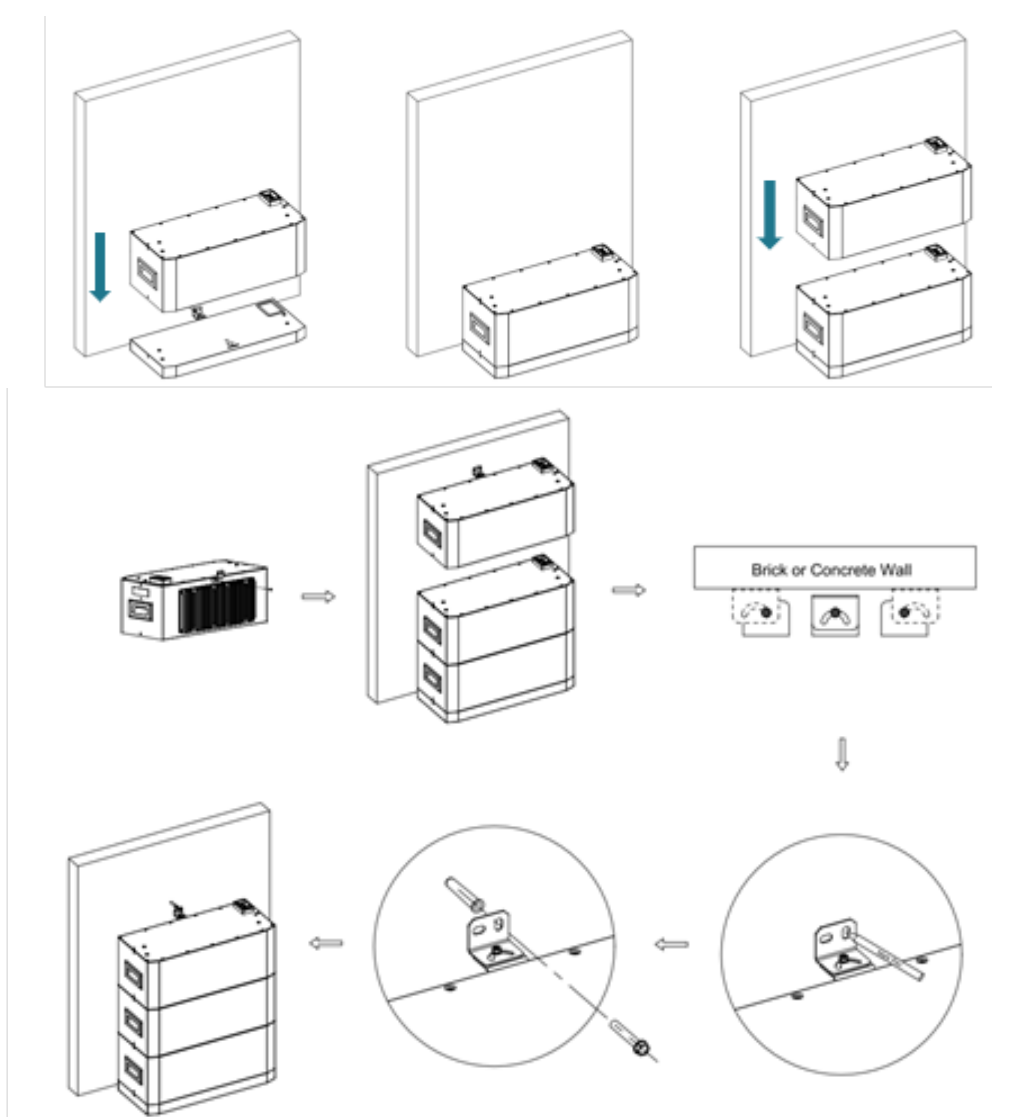

Figure 7 - Battery module installation diagram

6.5.3. Installing and Fixing the BDU

- 1) Place the BDU on the top of the battery module.
- 2) Fix the base, battery module and BDU on both sides with the side fixing brackets and M4 screws, until all modules are installed

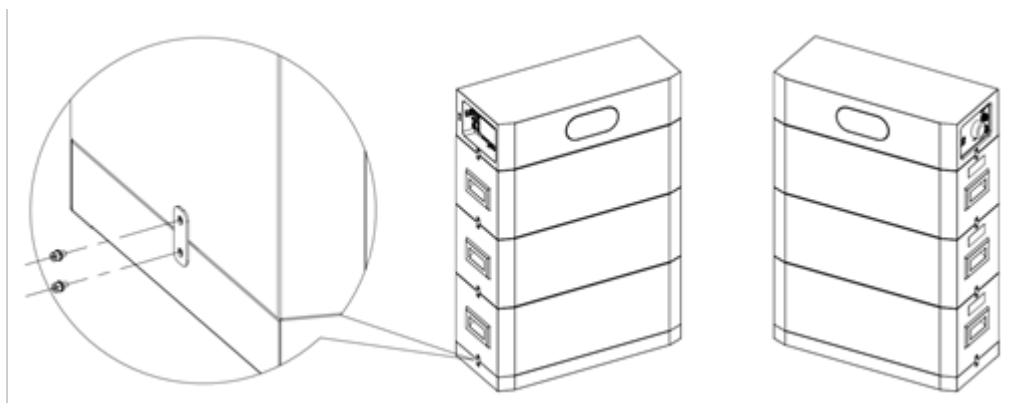

Figure 8 - Schematic diagram of fixing installation





Note

- ✓ The AZZURRO HV Smart 5K products can install up to 8 battery modules.

Electrical Connection

This product is used for ESS applications and this user manual only introduces the wiring from this battery module to the inverter.

 <p>Attention</p>	<ul style="list-style-type: none"> ✓ Only professional electrical engineers can install and maintain batteries. ✓ The equipment damage caused by operator's wrong wiring is not covered by the product warranty. ✓ When making electrical connections, wear rubber gloves and protective clothing. ✓ When connecting the device electrically, you must first connect the protection ground cable.
 <p>Danger</p>	<ul style="list-style-type: none"> ✓ Before electrical connection, ensure that the DC breaker of the BDU is OFF, and the battery module and the pcs are off. ✓ Ensure that the positive and negative cable connection from BDU to inverter is correct

Remove the grounding cables, communication cables, and power cable from the packaging and check if the cables are damaged.

- 1) Fix the grounding cable to the grounding hole of BDU using M5 screws, and fix the other end of the cable to the on-site grounding bus with a torque of 3 Nm;

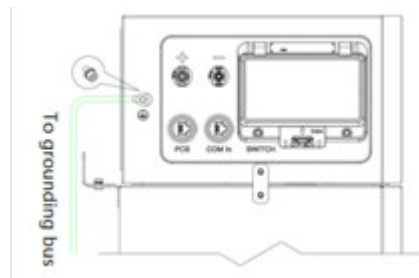

- 2) Connect the communication cable delivered with the accessories to the PCS port of the BDU, and connect the other end to the BMS communication ports CAN-H and CAN-L of the inverter respectively according to the label definition. (RJ45: Pin4_CAN-H, Pin5_CAN-L)
- 3) Connect the DC terminal connector of the power cable to the HV+/HV- input terminal on the BDU, and connect the other end to the inverter side. Ensure that the connection is secure

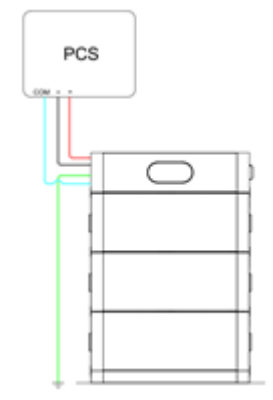

- 4) For different types of inverters, the architecture shown in the figure can also be formed through the cascade communication port on the BDU:
- 4.1. Connect the system grounding cable to the on-site grounding busbar through the grounding hole of the 1# BDU and 2# BDU.
 - 4.2. Connect the communication cable to the PCS port of the BDU, and connect the other end to the BMS communication ports CAN-H and CAN-L of the inverter respectively according to the label definition.
 - 4.3. Connect the communication cable delivered with the accessories from the COM OUT port of the 1# BDU to the COM IN port of the 2# BDU.
 - 4.4. Connect the DC terminal connector of the power cable to the HV+/HV- input terminal on the 1# BDU and 2# BDU ,and connect the other end to the BAT 1 and BAT 2 port of the inverter.

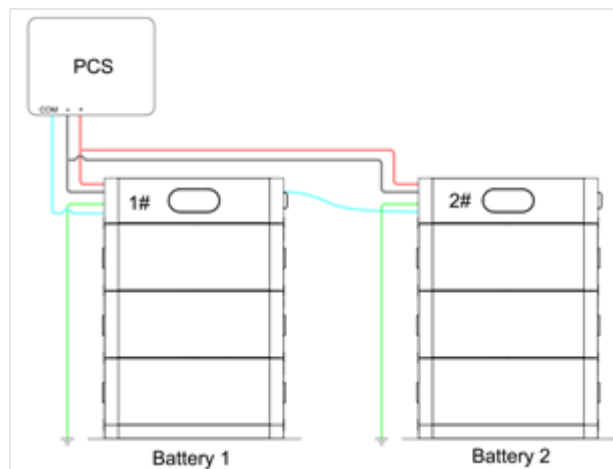

System operation

7.1. Check before power on

Please double check the following items before power on:

- ✓ Battery module, BDU and the base should be completely fixed.
- ✓ Each BAT+/BAT- line is firmly connected, the polarity is correct.
- ✓ The DC breaker of the BDU is Off.
- ✓ Install sealing plugs on unused terminals or interfaces.

7.2. Power-on

- ✓ Close the breaker on the BDU.
- ✓ Press START metal switch (3~6s) of the BDU to start up, LED indicator lights turn on successively.
- ✓ Close the breaker of the pcs and the pcs power is on.
If the indicator light shows no abnormalities, the battery can be charged and discharged.



Note

- ✓ Before charging, When the temperature of the battery module is above 0 °C, the battery module can be directly charged. When the battery temperature is below 0°C, the battery needs to be heated until the minimum temperature of the battery cell is greater than 8°C, before charging. The length of heating time depends on the current actual temperature. To heat the battery, an inverter needs to be connected. At this time, the SOC of battery being heated will not increase.

7.3. Power-off

- ✓ Make sure the system is not running.
- ✓ Open the breaker of the pcs and the pcs power is off.
- ✓ Press START metal switch (3~6s) of the BDU, and all LED indicators will be off in turn.
- ✓ Open the breaker on the BDU.



Danger

- ✓ After the product is powered off for a period of time, the HV+ and HV-terminal on the BDU are still charged. Please wait for more than 5 minutes until the capacitor is completely discharged.

Light indicator

8.1. The Product indicator light

The system indicator lights display the current battery level, power on, operation, and upgrade status of the module and BDU. The indicator light can easily identify the current operating mode of the system.

8.2. BDU indicator light



The BDU indicator lights display the mode, fault, and remaining capacity of the energy storage system.

RUN LED	<ol style="list-style-type: none"> 1. White on: Normal standby 2. White Flashing: Discharge state 3. Pink on: Breaker disconnected 4. Red on: System abnormality 									
ALM LED	<ol style="list-style-type: none"> ① On: System abnormality ② Off: System is normal <p>System abnormality include Alarm and Protection of batteries. Alarm: OV Protection: OV, UV, OC, OT, UT, Environment OT and UT, MOS OT, BUS OV, MOS damage.</p>									
Power LED	<p>(LED light in the inner circle)</p> <ol style="list-style-type: none"> ① White on: BDU is working normally ② Red on: System enters upgrade ③ Red Flashing: System is upgrading 									
SOC LED	<p>(10 LED lights in the outer circle) When charging, the highest SOC indicator light will flash</p>									
	SOC LED									
Remaining capacity	●	●	●	●	●	●	●	●	●	●
	LED1	LED2	LED3	LED4	LED5	LED6	LED7	LED8	LED9	LED10
[0,10%)	On	Off	Off	Off	Off	Off	Off	Off	Off	Off
[10%,20%)	On	On	Off	Off	Off	Off	Off	Off	Off	Off
[20%,30%)	On	On	On	Off	Off	Off	Off	Off	Off	Off
[30%,40%)	On	On	On	On	Off	Off	Off	Off	Off	Off
[40%,50%)	On	On	On	On	On	Off	Off	Off	Off	Off

[50%,60%)	On	On	On	On	On	On	On	Off	Off	Off	Off
[60%,70%)	On	On	On	On	On	On	On	On	Off	Off	Off
[70%,80%)	On	On	On	On	On	On	On	On	On	Off	Off
[80%,90%)	On	On	On	On	On	On	On	On	On	On	Off
[90%,100%]	On	On	On	On	On	On	On	On	On	On	On

Table 11 - LED indicator table for details

8.3. Battery module indicator light

The LED indicator light of the battery module displays the operating conditions, faults, and remaining battery status of the battery.

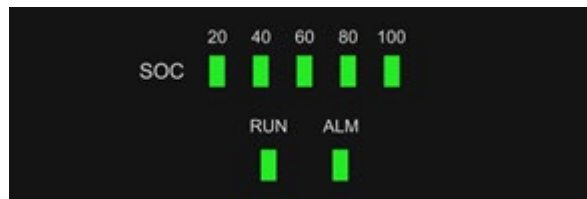

Status	Mode	RUN	ALM	SOC LED	Description
Power off	Sleep	Off	Off	All Off	
Standby	Normal	On	Off	Display actual remaining capacity	
	ALM	Flashing 1	Flashing 3		Alarm: OV, UV, OT, UT, Environment OT and UT, MOS OT, SOC Low. Protection: OV, UV, OC, OT, UT, Environment OT and UT, MOS OT, BUS OV.
CH	Normal	On	Off		The highest battery level LED Flashing.
	ALM	Flashing 2	Flashing 3		Alarm: OV, UV, OT, UT, Environment OT and UT, MOS OT.
	Protection	Flashing 1	Flashing 2		Protection: OV, UV, OC, OT, UT, Environment OT and UT, MOS OT, BUS OV, SC.
DCH	Normal	On	Off		
	ALM	On	Flashing 3		Alarm: OV, UV, OT, UT, Environment OT and UT, MOS OT, SOC Low.
	Protection	Flashing 1	Flashing 2		Protection: OV, OC, OT, UT, Environment OT and UT, MOS OT, BUS OV, SC.
	UV Protection	Flashing 1	Off		Protection: UV.

Status	Mode	RUN	ALM	SOC LED	Description
F		Off	On		BMS sampling device, MOS damage, temperature sensor disconnection, Voltage difference and temperature difference protection of battery cells, etc.

Table 12 – LED indicator table for details

Remaining capacity	SOC LED				
	●	●	●	●	●
	LED1	LED2	LED3	LED4	LED5
[0,20%)	Flashing	Off	Off	Off	Off
[20%,40%)	On	Flashing	Off	Off	Off
[40%,60%)	On	On	Flashing	Off	Off
[60%,80%)	On	On	On	Flashing	Off
[80%,100%]	On	On	On	On	Flashing

Table 13 –SOC LED indicator table for details

Below table shows the flashing type:

Flashing Type	Duration of indicator	Duration of indicator off
Flashing 1	0.25s	3.75s
Flashing 2	0.5s	0.5s
Flashing 3	0.5s	1.5s

Table 14 –Flashing Type for details



8.4. Description of Product Status abbreviation

Abbreviation	Full Name	Abbreviation	Full Name
CH	Charge	OC	Over-current
DCH	Discharge	OCH	Overcharge
RUN	Work normally	SC	Short-circuit
ALM	Alarm	F	BMS sampling device, MOS damage, temperature sensor disconnection, Voltage difference and temperature difference protection of battery cells, etc.
UV	Under-voltage		
OV	Over-voltage		
UT	Under-Temperature		
OT	Over-Temperature		

Table 15 -Anomalies abbreviation

Product Storage and Daily Maintenance

9.1. Product storage

If the product will not be put into use immediately, please store it according to the following requirements:

- ✓ Make sure that the outer packing box is not removed, and the desiccant in the box is not lost.
- ✓ Do not place the cell in direct sunlight or heat source to prevent high temperature of the cell.
- ✓ Make sure that the stacking height and direction of the product comply with the instructions.
- ✓ Make sure that there is no risk of tipping over after the products are stacked.
- ✓ Ensure that the storage environment of the product (battery module and BDU) meets the requirements: temperature $-10 \sim 45^{\circ} \text{C}$, humidity $\leq 85\%$.

9.2. Maintenance

9.2.1. Regular Maintenance

Please charge the battery module according to the following requirements with the charging current is less than or equal to 3A.

Short-term storage:

- ✓ Storage conditions of module: temperature $-10 \sim 45^{\circ}\text{C}$, humidity $\leq 85\%$, state of charge 15%~ 45% SOC.
- ✓ It is recommended that batteries operate within one month after shipment, so as to avoid the capacity loss and voltage attenuation caused by the self-discharge of lithium ion battery.

Long-term storage:

- ✓ Storage conditions of module: temperature $-10 \sim 45^{\circ}\text{C}$, humidity $\leq 85\%$, state of charge 30% ~ 60% SOC.
- ✓ If batteries are not charged for over 3 months, please charge and discharge batteries for 2-3 cycles to ensure best performance.
- ✓ If the battery module is stored for a long time, replenish the power supply periodically. Battery module power supply requirements: the charging current is less than or equal to 7A, and the battery module needs to be charged to 50%SOC.

Recharge Requirements During Normal Storage

When the battery is stored for a long time, you need to perform regular maintenance. If the storage time is close to that shown in the following table, arrange supplementary power supply in time.

Recharge conditions when in storage

Storage Environment Temperature	Relative Humidity of Storage Environment	Storage Time	SOC
< -10°C	/	Prohibit	/
-10°C ~ 25°C	5% ~ 70%	≤ 12 months	30% ≤ SOC ≤ 60%
25°C ~ 35°C	5% ~ 70%	≤ 6 months	30% ≤ SOC ≤ 60%
35°C ~ 45°C	5% ~ 70%	≤ 3 months	30% ≤ SOC ≤ 60%
> 45°C	/	Prohibit	/



Attention

- ✓ After the product has been stored for a long time, it must be checked and confirmed by professionals before it can continue to be used.

9.2.2. Daily Maintenance

Ensure that the product is not covered with dust, dirt, etc.

When cleaning products, please turn off the system and wait for 5 minutes to be aware of the risk of electric shock.

Clean the battery module

- ✓ Please clean the battery module with an air blower, a dry & soft cloth or a soft bristle brush.
- ✓ Do not clean the inverter with water, corrosive chemicals, detergent, etc.

Clean the Radiator:

- ✓ In order to ensure the normal function and long service life of the product, it is necessary to ensure that there is enough air flow space around the radiator at the rear of the product, and there is no material around the radiator that obstructs the air flow, such as dust or snow, must be removed.
- ✓ Clean the Radiator with the soft cloth, or a soft brush.
- ✓ Do not use water, corrosive chemicals, cleaning agents, or strong detergents to clean the radiator.

9.2.3. System expansion and replace of battery modules

Adding or removing battery modules must be carried out by professional technicians.

System expansion:

- ✓ Please shutdown system and disconnect the switches of inverter, load, and PV.
- ✓ Disconnect the circuit breaker on the BDU.
- ✓ Remove the cables connected to the BDU.
- ✓ Remove the side fixing brackets between the module and BDU in the opposite order of installation.
- ✓ Remove the BDU and the back bracket of the top battery module, and then remove the top battery module.
- ✓ Stack all new battery modules and the top battery module (with the back bracket)
- ✓ Select any installation hole on the bracket and mark it, then remove the battery pack and drill a hole.
- ✓ Install the plastic expansion tube in the installation hole and replace the battery pack, and secure the back bracket with M6 self-tapping screws.
- ✓ Place the BDU on the top of the battery module.
- ✓ Fix the top battery module and BDU on both sides with the side fixing brackets and M4 screws.
- ✓ Complete the wiring in the order of wiring, communication, and power lines.

Replacement of battery modules:

- ✓ If the battery module malfunctions and needs to be replaced, please refer to the system expansion steps for replacement.
- ✓ The system must be powered off before operation, and the new battery modules can be stacked in any layer.

9.2.4.Troubleshooting

Due to installation environment, improper operation, and other reasons, the product may experience abnormal alarms or protection during operation. Users can understand the abnormal status of the battery through indicator lights or monitoring software. Once the user knows the fault Phenomenon, refer to the following sections for solutions.

The definition of abnormal state is as follows:

- ✓ Alarm: An abnormal state occurs in the energy storage system, causing a decrease in power or partial functional abnormalities in the energy storage system.
- ✓ Protection: In the event of a malfunction in the energy storage system, the system or faulty battery module will shut down.

Fault Phenomenon	Cause	Solution
BDU has no normal voltage output	1. The DC breaker is open. 2. Power module failure.	1. Close the DC breaker. 2. Confirm if the power module is functioning properly.
Energy storage power module failure	1. Installation position of energy storage power control module Not ventilated. 2. The ambient temperature is too high or low. 3. Overload operation of energy storage system 4. Hardware malfunction	1. Check for good ventilation and ambient temperature at the product installation location. Does the temperature exceed the maximum allowable ambient temperature range Surrounding. 2. If there is no ventilation or the ambient temperature is too high, please improve its ventilation and heat dissipation conditions. 3. Please use the maximum load allowed by the system. 4. If the fault has not been eliminated yet, please contact the local engineer. 5. Check the communication and power cable of the energy storage system.



Fault Phenomenon	Cause	Solution
Energy storage battery module short circuit	<ol style="list-style-type: none"> Short wiring of energy storage battery expansion module Energy storage battery expansion module equipment is abnormal. 	<ol style="list-style-type: none"> Disconnect the breaker of BDU and shut down the system and wait for 5 minutes. Check the power wiring. If the cable is damaged or short circuited, it needs to be checked. Replace with a new cable. Check if there are any other faults in the power module. If the alarm still persists, contact the dealer or customer service center.
Button startup of BDU failed	The production is not activated by the button, and the battery cannot be turned on	<ol style="list-style-type: none"> Check the status of buttons and cables. Start up and check the BMS status through monitoring software. Activate BMS through external voltage. If there is a hardware malfunction, please contact the local engineer.
Charging/discharging Over Temperature	The battery temperature is higher than the upper limit temperature threshold for battery operation.	<ol style="list-style-type: none"> Install the battery in the allowed temperature environment. Restart after 1 hour of system shutdown
Charging/discharging under Temperature	The battery temperature is below the lower limit temperature threshold for battery operation.	<ol style="list-style-type: none"> Install the battery in the allowed temperature environment. When the battery is under low-temperature charging protection, connect the inverter to heat the battery. When the temperature of the battery unit exceeds the threshold, it will be charged.
Ambient Over Temperature	The ambient temperature of the battery is higher than the maximum allowable temperature of the system	<ol style="list-style-type: none"> Please install the battery in the allowed temperature environment according to the user manual.



Fault Phenomenon	Cause	Solution
Ambient Temperature under	The ambient temperature of the battery is lower than the maximum allowable temperature of the system	1. Please install the battery in the allowed temperature environment according to the user manual
MOS Temperature Over	The MOS temperature of the BMS is higher than the maximum allowable temperature.	1. Please shut down the system. 2. Restart after 1 hour. 3. If the malfunction occurs again, please contact the local engineer.
Charging/discharging Over Current	Due to load or hardware reasons, the charging and discharging current is above the threshold.	1. Restart the inverter to see if the fault still exists. If it still exists, please contact the local engineer.
Charging Voltage Over	Cell or battery voltage above threshold.	1. Shut down the system 2. Measure the battery port voltage and the BMS detection voltage to be the same. 3. Check if the battery cell is abnormal. 4. If the fault cannot be eliminated after 1 hour, please contact the local engineer.
Discharging Voltage under	Cell or battery voltage below threshold	1. Please charge immediately until the fault disappears. 2. Check if the battery cell is abnormal. 3. If the fault occurs frequently, please contact the local engineer.
Internal Fault	System production cable and hardware failure, unable to charge and discharge	1. Check if the internal cables are functioning properly. 2. Check BMS for any errors. 3. Check if the sampling line of the battery cell. 4. If the fault cannot be eliminated, please contact the local engineer.



Fault Phenomenon	Cause	Solution
Cell voltage difference protection	The voltage difference between battery cells exceeds the threshold	<ol style="list-style-type: none"> 1. Measure the actual voltage of the battery cell through an instrument. 2. Battery damage, please contact the local engineer.
Cell temperature difference protection	The temperature difference between battery cells exceeds the threshold	<ol style="list-style-type: none"> 1. Please shut down the system. 2. Restart after 1 hour. 3. If the malfunction occurs again, please contact the local engineer.
Low Battery	Battery level below threshold due to prolonged standby or discharge	<ol style="list-style-type: none"> 1. Please charge immediately until the fault disappears.



Connect X APP

10.1. Overview

XConnect APP is a mobile app that can communicate with the Battery through WiFi or Bluetooth. The following are commonly used functions:

- ✓ Monitor system data, alarm information, software version of the equipment.
- ✓ Set the parameters of the Battery.
- ✓ Maintain the equipment.

When installing the device, you need to initialize your APP according to the following steps:

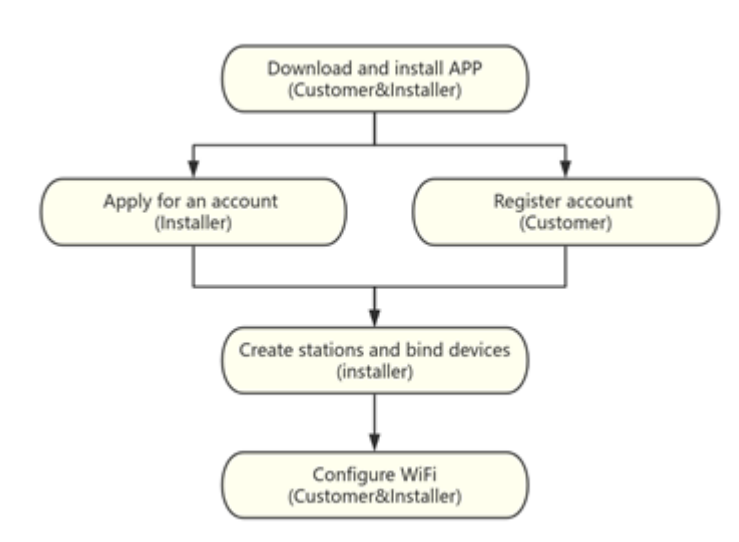

10.2. Download and install APP (Customer & Installer)

Search for the Connect X APP in Google Play (Android) or APP Store (IOS), download and install it.

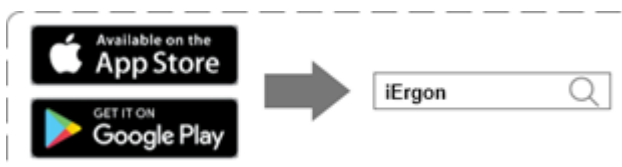

10.3. Apply for an account (Installer)

Installer need to apply for an account with the manufacturer or the superior agent.
Proceed through the following steps:

- ✓ Apply for an account
- ✓ Choose the account type <Agent> on the login page, and enter the account obtained in step 1 to log in

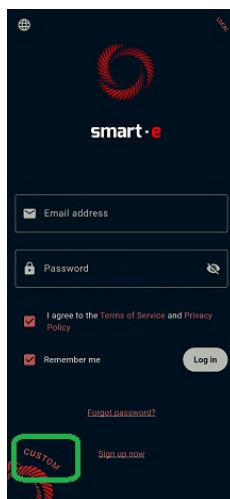

10.4. Register account (Customer)

The registration function is provided for end users and is one of the necessary steps for device activation to the platform.

Proceed through the following steps:

- 1) Choose the account type <Customer> on the login page
- 2) Click Sign up now at the bottom of the login page
- 3) Enter name, date of birth, email, and phone number in order
- 4) Confirm your email on the final confirmation page, and click Sign in now
- 5) The platform will send a confirmation email to your email within 24 hours, click Active Your Account in the email to open the password setting page
- 6) Set your password in the password setting page. If registration is successful, a prompt will be displayed: "User has been successfully activated!"

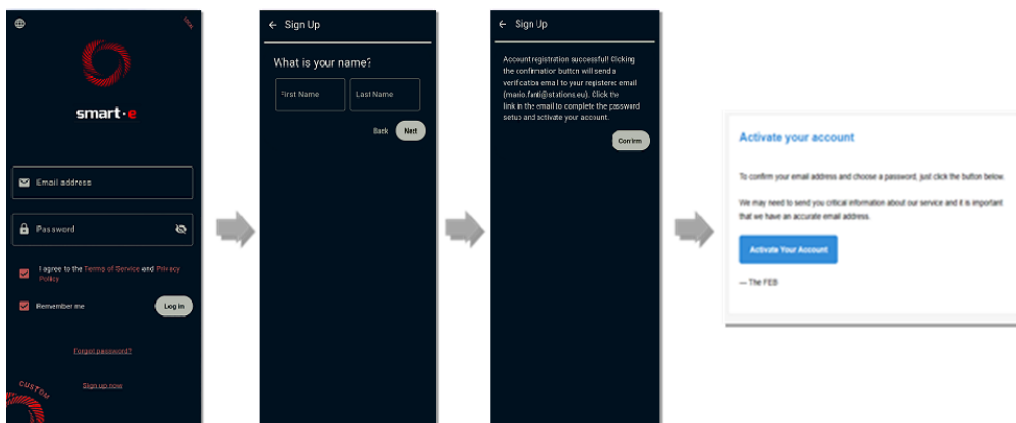

10.5. Create Stations and bind devices (Installer)

Creating stations and binding devices is one of the necessary steps for device installation. After completion, customers can view these stations and devices.

Proceed through the following steps:

- 1) Click the Create button on the station list page to open the Create Station page
- 2) On the page of creating station, fill in the information and create (Please fill in the email of the customer who owns this station)
- 3) Find the created station in the station list and click
- 4) On the page of station, click the Add New Device button and scan the bar code on the device body to bind the device

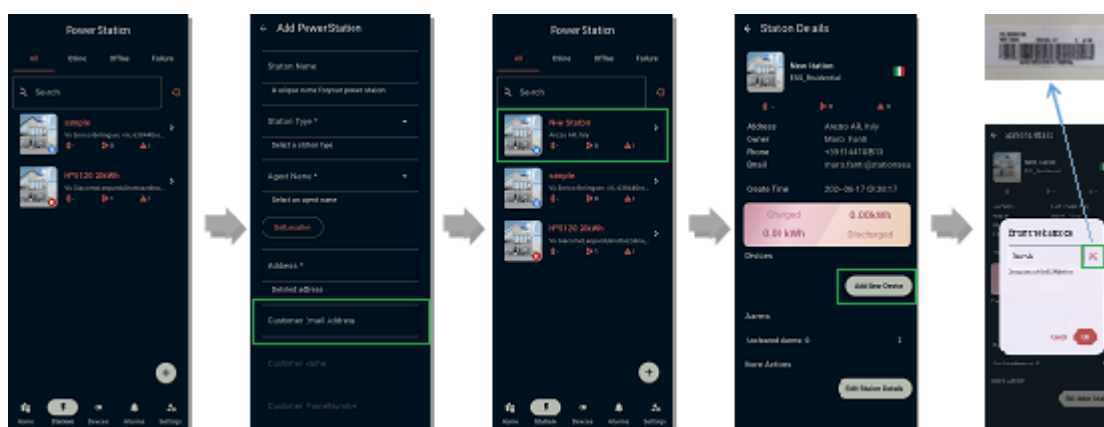

10.6. Configure WiFi (Customer & Installer)

Configuring one of the necessary steps for device installation, before WiFi configuration, it is necessary to ensure that 2.4GHz Wi-Fi is available nearby (generally, if a router has 5GHz Wi-Fi, it must have 2.4GHz Wi-Fi. If 2.4GHz Wi-Fi is turned off, it needs to be turned on the router).

Proceed through the following steps:

- 1) Make sure that the device is turned on normally;
- 2) Find the device in the device list and click;
- 3) On the page of device, click the more button to the right of the title;
- 4) Click the WiFi Provisioning button to complete the WiFi configuration;
- 5) After the WiFi configuration is successful, the device will be displayed as online;



Note

- ✓ If the device has been configured with a network, it will not be able to connect to the Bluetooth of the device after 1 minute; If the connection is unsuccessful for a long time, please restart the device and try to connect again within 1 minute.

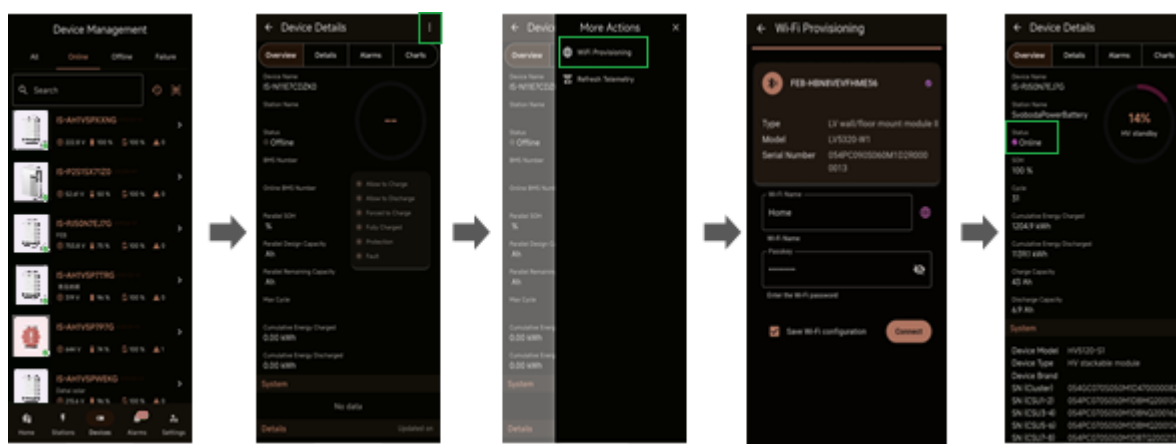

Technical Parameters

ZCS AZZURRO HV SMART 5K

Technical data

Model	ZCS – AZZURRO HV SMART 5K
Code	ZZT-BAT-AHV5K
Technology	Lithium Iron Phosphate
Dimensions (H*L*W)	240mm*640mm*270mm
Weight	50 Kg
Protection class	IP65
Mounting	On ground, stackable
Cable kit for connection	Included with battery
BMS	Integrated (requested external Azzurro BDU Smart 5K for High Voltage protection - ZZT-AHV5K-BDU)
Range of charging operating temperature*	-15°C - +50°C
Range of discharging operating temperature *	-20°C - + 50°C
Range of operating humidity	0...95% non-condensing
Maximum operative altitude	2000m
Operating cycles under standard conditions **	8000
Maximum number of batteries that can be installed in parallel	8
Certifications	IEC/EN 61600-6-1, IEC 61600-6-3, IEC62619, IEC62040, CE, UN38.3 (updated list www.zcsazzurro.com)
Warranty	10 years
Communications	RS485, CAN bus

Capacity data

Single module nominal capacity	5.12 kWh
Single module useful capacity (Depth of Discharge 90%)	4.61 kWh
Total useful capacity (Depth of Discharge 90%)	From 4.61 kWh (single module) to 36.88 (8 modules in parallel)
Nominal voltage	400 V
Maximum charging current***	From 6.3A (single module) up to 50A (8 modules)
Maximum discharging current***	From 12.5A (single module) up to 50A (8 modules)
Maximum Depth of Discharge	90%

* to guarantee maximum performance, installation in a controlled temperature environment between 15°C and 40°C is recommended (below 15°C the batteries protect themselves by limiting the charging current and below 0°C batteries stop charging to let the heating of the modules)

**Standard operating conditions for batteries: ambient temperature 25°C, relative humidity 40%, depth of discharge 80%

***Actual charging and discharging currents may be limited by the operating conditions of the battery, as well as the inverters to which the batteries are connected. Please refer to the inverter data sheet for the actual charging and discharging current.

Disposal

Zucchetti Centro Sistemi S.p.a. is not liable for the disposal of the equipment, or parts thereof, that does not take place according to the regulations and standards in force in the country of installation.



The symbol of the crossed-out wheeled bin indicates that the equipment, at the end of its useful life, must be disposed of separately from household waste.

This product must be handed over to the waste collection point in your local community for recycling.

For more information, please contact the waste collection authority in your country.

Inappropriate waste disposal could have negative effects on the environment and on human health due to potentially hazardous substances.

With your cooperation in the correct disposal of this product, you contribute to the reuse, recycling and recovery of the product, and to the protection of our environment.

Warranty terms and conditions

To view the "Warranty Terms and Conditions" offered by ZCS Azzurro, please refer to the documentation inside the product box and on the website www.zcsazzurro.com.

The product has an IP65 degree of protection, a parameter defined by the international standard IEC 60529. This standard assesses the effectiveness of electrical enclosures in protecting against intrusion of objects, water, dust and accidental contacts.

For this product, specifically results:

- ✓ Completely airtight with dust and fumes.
- ✓ Protected against water jets coming from any direction.

To ensure consistent performance over time, avoid exposing the product to extreme temperatures and adverse weather conditions. Always ensure that the installation environment meets the technical specifications set out in this manual.



THE INVERTER THAT LOOKS AT THE FUTURE

zcsazzurro.com



Zucchetti Centro Sistemi S.p.A.
Green Innovation Division
Palazzo dell'Innovazione - Via Lungarno, 167
52028 Terranuova Bracciolini - Arezzo, Italy
zcscompany.com

