



USER'S MANUAL



EV CHARGER CARO

1PH 7KW 3PH 11KW



ZUCCHETTI
Centro Sistemi





EV CHARGE CARO 1PH 7kW/3PH 11kW User Manual



General instructions

This manual contains important safety instructions that must be followed during installation and maintenance of the equipment.

Please keep these instructions!

This manual must be considered an integral part of the equipment, and must be available at all times to everyone who interacts with the equipment. The manual must always accompany the equipment, even when it is transferred to another user or plant.

Copyright statement

Copyright of this manual belongs to Zucchetti Centro Sistemi S.p.A. No part of this manual may be copied (including the software), reproduced or distributed in any form or by any means without the permission of Zucchetti Centro Sistemi S.p.A. All rights reserved. ZCS reserves the right to final interpretation. This manual is subject to change based on feedback from users, installers or customers. Please check our website at <http://www.zcsazzurro.com> for the latest version.

Technical support

ZCS offers a support and technical consultancy service accessible by sending a request directly from the website www.zcsazzurro.com

The following toll-free number is available for the Italian territory: 800 72 74 64.

Table of Contents

1. Safety instructions	8
1.1. Safety and Warnings.....	8
1.2. Safety instructions	9
1.3. Symbols and icons	13
1.4. Labels	14
2. Product Overview	15
2.1. Product Features	15
3. Exterior Overview	18
3.1. Cable Model.....	18
3.2. Model variant	18
4. Technical Specification.....	19
5. Installation	20
5.1. Checks before installation	20
5.1.1. Required Cable and Accessory	23
5.1.2. Installation tools	24
5.2. Installation Details	26
5.2.1. Installation position	26
5.2.2. Movement of the charger	26
5.3. Opening	27
5.4. Install wall mounting screw:.....	28
5.5. Hang the enclosure on the screws	29
5.6. Connect power cable.....	29
5.7. Connect Ethernet cable	30
5.8. Connect RS485 cable & CT.....	31
5.9. Secure the enclosure and faceplate of the charger	31
6. Operation and Configuration.....	32
6.1. Charging Operation - Plug & Charge	32



- 6.2. Configuration34
 - 6.2.1. By APP34
 - 6.2.2. By AP Mode34
 - 6.2.2.1. Preparation.....35
 - 6.2.2.2. Login35
 - 6.2.2.3. Configuration:.....36
- 6.3. Charging APP38
 - 6.3.1. App Introduction38
 - 6.3.2. Download & Installation38
 - 6.3.3. Sign Up and Log In39
 - 6.3.4. Bind Charger to App40
 - 6.3.5. Select Communication Mode41
 - 6.3.6. Set Maximum Charging Current42
 - 6.3.7. Transfer Ownership to End User43
 - 6.3.8. Charging Operation44
- 7. Dynamic Load Balancing47
 - 7.1. Wiring for Dynamic Load Balancing.....48
 - 7.1.1. Introduction Load Balancing.....48
 - 7.1.2. Supported EV Chargers.....48
 - 7.1.3. Applicable Scenarios and Required Accessories48
 - 7.1.4. Specifications.....49
 - 7.1.5. Hardware Wiring50
 - 7.2. Software configuration52
 - 7.2.1. Configured via APP52
 - 7.2.2. Configured via AP mode53
- 8. Indicator53
- 9. Troubleshooting and maintenance.....55
 - 9.1. Troubleshooting Common Faults55
 - 9.2. Troubleshooting Technical Faults.....56
 - 9.3. Maintenance.....57



9.4.	Storage and Transportation.....	58
9.5.	Disassembly	58
9.6.	Disposal/Scrapping	58
10.	Warranty	59

Preface

General information

Please read this manual carefully before installation, use or maintenance. This manual contains important safety instructions that must be followed during installation and maintenance of the system.

Scope

This manual describes the assembly, installation, electrical connection, commissioning, maintenance and troubleshooting of the EV CHARGE CARO series:

1PH 7kW

3PH 11kW



Keep this manual so that it is accessible at all times.



Recipients

This manual is intended for qualified technical personnel (installers, technicians, electricians, technical support personnel or anyone who is qualified and certified to work on an electrical system), responsible for installing, starting up and operating the charging station.

Symbols used

This manual provides information for safe operation and uses certain symbols to ensure the safety of personnel and materials, and for efficient use of the equipment during normal operation. It is important to understand this information to avoid accidents and damage to property. Please take note of the following symbols used in this manual.

	<p>Danger: indicates a hazardous situation which, if not resolved or avoided, could result in serious personal injury or death</p>
	<p>Warning: indicates a hazardous situation which, if not resolved or avoided, could result in serious personal injury or death</p>







	<p>Caution: indicates a hazardous situation which, if not resolved or avoided, could result in minor or moderate personal injury</p>
<p>Caution</p>	
	<p>Attention: indicates a potentially hazardous situation which, if not resolved or avoided, could result in damage to the system or other property</p>
<p>Attention</p>	
	<p>Note: provides important tips on the correct and optimal operation of the product</p>
<p>Note</p>	





1. Safety instructions

	<p>If you have problems or questions in reading and understanding the following information, please contact Zucchetti Centro Sistemi S.p.A. through the appropriate channels.</p>
Note	

1.1. Safety and Warnings

Save these instructions. Read all instructions before installing or using the charger.

	<p>Keep the charger away from explosive or flammable materials, chemicals, vapours and other hazardous objects</p>
	<p>Keep the charge point socket clean and dry. If it gets dirty, please wipe it with a clean, dry cloth</p>
	<p>Do not touch the socket pin when the unit is powered on</p>
	<p>Do not use the charge point if it is showing any visible product damage such as cracks, abrasions, bare leakage, and other visible defects. At first sight of such damages, immediately contact a qualified technician</p>
	<p>Do not attempt to disassemble, repair or refit the charge point. If necessary, please contact the qualified technician. Improper operation will result in device damage, electric leakage and other hazards</p>
	<p>In case any abnormal condition happens, please turn off incoming power supplies immediately</p>

	<p>Please consider charge point protection against lightning and heavy rain</p>
	<p>Keep children away from the charge point</p>
	<p>During charging, do not drive the EV. Charge only when the EV is stationary. For hybrid cars, charge only when the engine is switched off</p>
	<p>Our packaging materials are environmentally friendly and can be recycled. Please put the packaging in applicable containers to recycle it. Do not dispose of this device with the household waste. It should be taken to a suitable facility for recycling of electrical and electronic devices. For more detailed information about recycling of this device, please contact your local city/town council office or your household waste disposal service</p>

	<p>The device can be in electrically energized state. There is risk of shock and electrical hazard. Please strictly observe all warnings on the device and user manuals. The cover of the charge point is only to be removed by a qualified electrician</p>
<p>Warning</p>	

1.2. Safety instructions

Highlights the safety instructions to be followed during installation and use of the equipment.

Before installing and using the equipment, make sure you read and understand the instructions in this manual and familiarise yourself with the relative safety symbols shown in this chapter.

According to national and local requirements, permission must be obtained from your local provider before connecting to the electrical grid, making sure that the connections are carried out by a qualified electrician. All installation work must be carried out by a qualified and competent electrician.

Contact the nearest authorised service centre for any repairs or maintenance. Contact your distributor for information on the nearest authorised service centre. **DO NOT** carry out repairs yourself, as this may result in injury or damage.

Qualified personnel

Ensure that the operator has the necessary skills and training to operate the equipment. Personnel responsible for use and maintenance of the equipment must be qualified and capable of performing the activities described, and must also have appropriate knowledge on how to correctly interpret the contents of this manual. For safety reasons, this charging station can only be installed and serviced by a qualified electrician with the necessary training and/or skills and knowledge. Zucchetti Centro Sistemi S.p.A. declines all responsibility for damage to property or personal injury caused by incorrect use of the device.

Do not attempt in any way to repair or replace components of the charging station without the assistance of qualified personnel.

Installation requirements

Install and start the charging station according to the following instructions. Place the charging station on suitable load-bearing supports with sufficient load capacity (such as metal walls or columns) and make sure it is positioned vertically. Choose a suitable location for the installation of the electrical equipment. Make sure there is sufficient space for heat dispersion and to accommodate future maintenance. Maintain adequate ventilation and ensure that there is enough air circulation for cooling.

The charging station display must not be exposed directly to sunlight.



Danger

Do not place the charging station near explosive, flammable materials, chemical vapours or potentially hazardous materials.





Figure 1 – Do not lose or damage this manual

Transport requirements

If you encounter problems with the packaging that could damage the charging station or if you find any visible damage, immediately notify the transport company. If necessary, request assistance from an installer or from Zucchetti Centro Sistemi S.p.A. Transport of the equipment, especially by road, must be carried out with vehicles suitable to protect the components (in particular, electronic components) against violent knocks, humidity, vibrations, etc.

Electrical connections



Please follow all the electrical regulations on accident prevention.

	Before connecting the electrical cables, make sure to properly disconnect the voltage on the AC connection cables, and do not connect any charging cables for electric vehicles.
Danger	
	All installation operations must be carried out by a professional electrician, who has carefully read this manual and understands its contents!
Warning	
	Before connecting the charging station to the grid, make sure that all the necessary permits have been obtained from the local grid operator and that all the electrical connections have been completed by a professional electrician.
Attention	

	<p>Do not remove the information label or tamper with the charging station. Otherwise, ZCS will not provide any warranty or assistance</p>
Note	

Operation

Do not use the product if it has any defects, cracks, scratches or leaks, but contact your dealer or ZCS technical service.

	<p>Contact with the electrical grid or the terminal of the equipment may cause electrocution or fire!</p> <ul style="list-style-type: none"> Do not touch the terminal or the conductor connected to the electrical grid. Follow all the instructions and safety requirements relating to grid connection
Danger	
	<p>If the charging station is not functioning properly:</p> <ul style="list-style-type: none"> Disconnect the input and output power supply
Warning	
	<p>Take special care when charging in thunderstorms or in rain</p>
Attention	

Maintenance and repair

Keep the charging station clean and dry; if you need to clean it, use a clean dry cloth. It is very dangerous to touch the inside of the charging station, therefore it is strictly forbidden to do so while the system is running. NEVER clean the inside of the charging station with a wet or damp cloth.

	<ul style="list-style-type: none"> Before performing any repairs, disconnect the charging station from the power supply (AC side) and from the data connection to the transmission gate. After switching off the DC switch, wait 5 minutes before carrying out any repairs or maintenance on the charging station
Danger	

	<ul style="list-style-type: none"> • The charging station should start working again after any faults have been fixed. For repairs, contact your local authorised service centre • Do not disassemble the internal components of the charging station without permission; this will void the warranty.
Attention	

1.3. Symbols and icons

Introduces the main safety symbols on the charging station. Some safety symbols are located on the charging station. Read and understand the contents of the symbols before installation:





	Be careful of high voltage
	Complies with the European Standards
	Ground connection point
	Read this manual before installing the charging station.
	<p>Degree of protection of the equipment according to the IEC 70- 1 standard (EN 60529 June 1997). IP65 means that it is resistant against water and rust, therefore also suitable for outdoor operation and maintenance.</p>

Table 1 – Symbols present on the charger

1.4. Labels

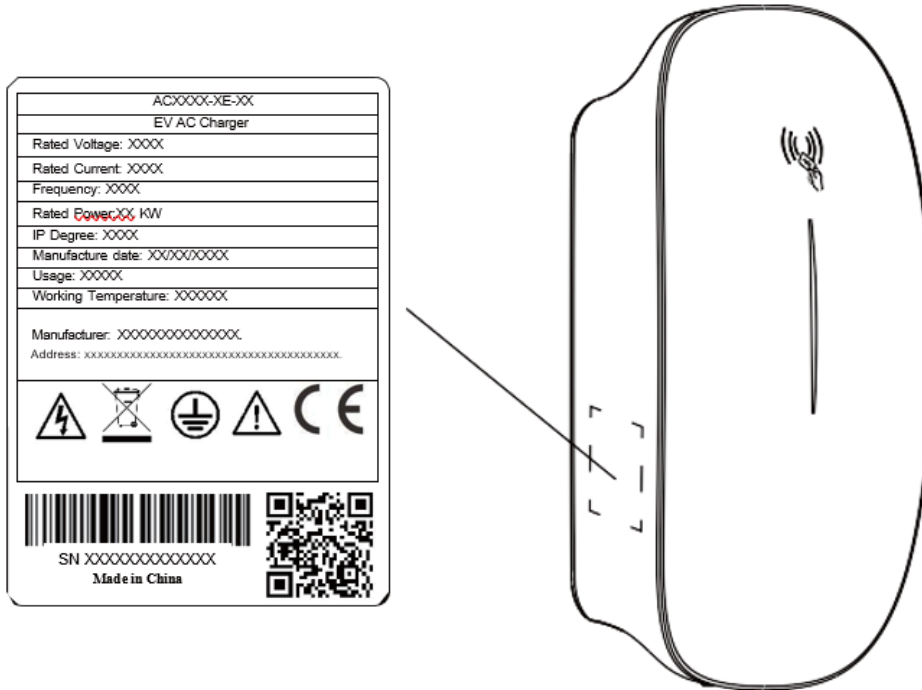

Figure 2 - Labels present on the charging station



DO NOT remove the labels. **DO NOT** cover with sheets, supports, cabinets, etc. Always keep them clean and legible.

2. Product Overview

The Caro Product specified in this document is design for the market to charge European Standard plug-in electric vehicles (PEVs), plug-in hybrid electric vehicles (PHEVs), and battery electric vehicles (BEVs). It provides EU standard Type 2 AC charger cable connector.

2.1. Product Features

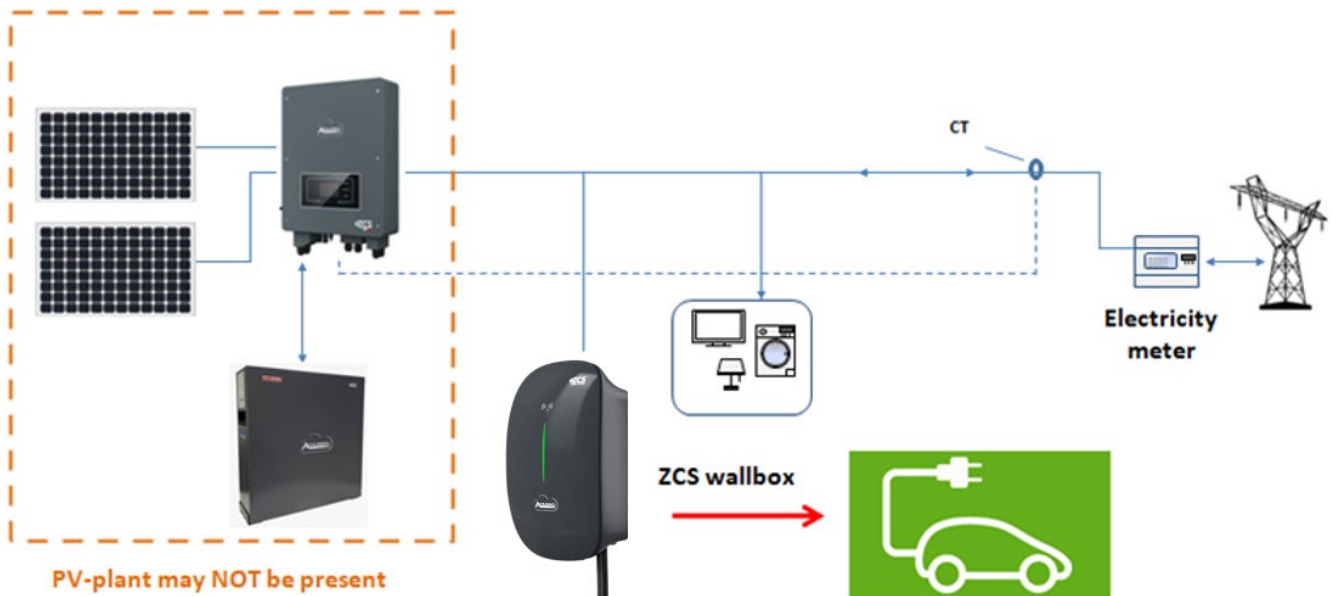



Figure 3 – Example of a charging station connected to a PV system (optional) and grid

- ✓ **Universal Type 2 cable lead.**
- ✓ **Power rating – Up to 7kW or 11kW models.**
- ✓ **Adjustable power rating: 7kW: 6~32A, 11kW: 6~16A.**
- ✓ **Intelligent Authentication:**
 - Support charging user identification on online mode or Bluetooth mode.
 - Smart RFID/Bluetooth/App Authentication.
 - Supports plug to charge while authentication is off.
- ✓ **Multiple charge modes:**
 - Plug to Charge
 - General mode: start charging via RFID card, start charging via App

- Remotely start charging via App
 - Scheduled charge via App
 - Eco Mode*
 - EMS compatible*
- ✓ **Built-in LED charging status indicator.**
 - ✓ **Network connectivity: WiFi, Ethernet or 4G.**
 - ✓ **OCPP 1.6 compliant.**
 - ✓ **CE and CB certified.**
 - ✓ **Dynamic Load Balancing:**

The Caro Serials charger has a Dynamic Load Balancing capability which is designed to prevent overloads of the property's power supply when a electric vehicles is being charged.

Once correctly installed and configured, the system will monitor the power being drawn by the charging process and will compare this to the permissible maximum for the property as a whole (need to be set). With this information, the power made available for charging can be dynamically adjusted to reduce the load before the property's maximum load is exceeded.

	<ul style="list-style-type: none"> • Load balancing ONLY controls power made available to the VEHICLE. It does not control power to other equipment(home applications) ,and it is still possible that other equipment cause overload the property's power supply. Please address the source of the equipment that actually caused the overloading. • Depending on the manufacturer, electric vehicles need a minimum of around 6 Amps to charge. If the available power is below this level, the vehicle may stop the charge session. • In order to monitor the total load, extra current transformer / smart meter are needed. • The lower the power available for charging, the more slowly the vehicle will be charged.
Attention	

- ✓ **PV energy utilization**

The Caro Series chargers can utilize photovoltaic generation and energy storage technologies to offer a clean, efficient, and reliable power supply for electric vehicles, thereby diminishing reliance on conventional power grids and fostering the adoption of green energy.

This requires extra accessories, please contact our technical support for more information.



Attention

- **PV energy refers to the electricity produced by solar panels that transform sunlight into a usable power source for homes and businesses.**

✓ **Energy management system (EMS) integration**

The Caro Series chargers are designed with dedicated ports to ensure seamless integration with various EMS systems, providing flexible energy management solutions. For details about EMS, please contact our technical support for more information.



Attention

- **The Energy Management System (EMS) is like an intelligent butler that monitors your energy usage, automatically adjusts the operation of devices, and uses energy in the most economical and efficient way, while ensuring safety and reducing waste, helping you save money and protect the environment.**

3. Exterior Overview

3.1. Cable Model

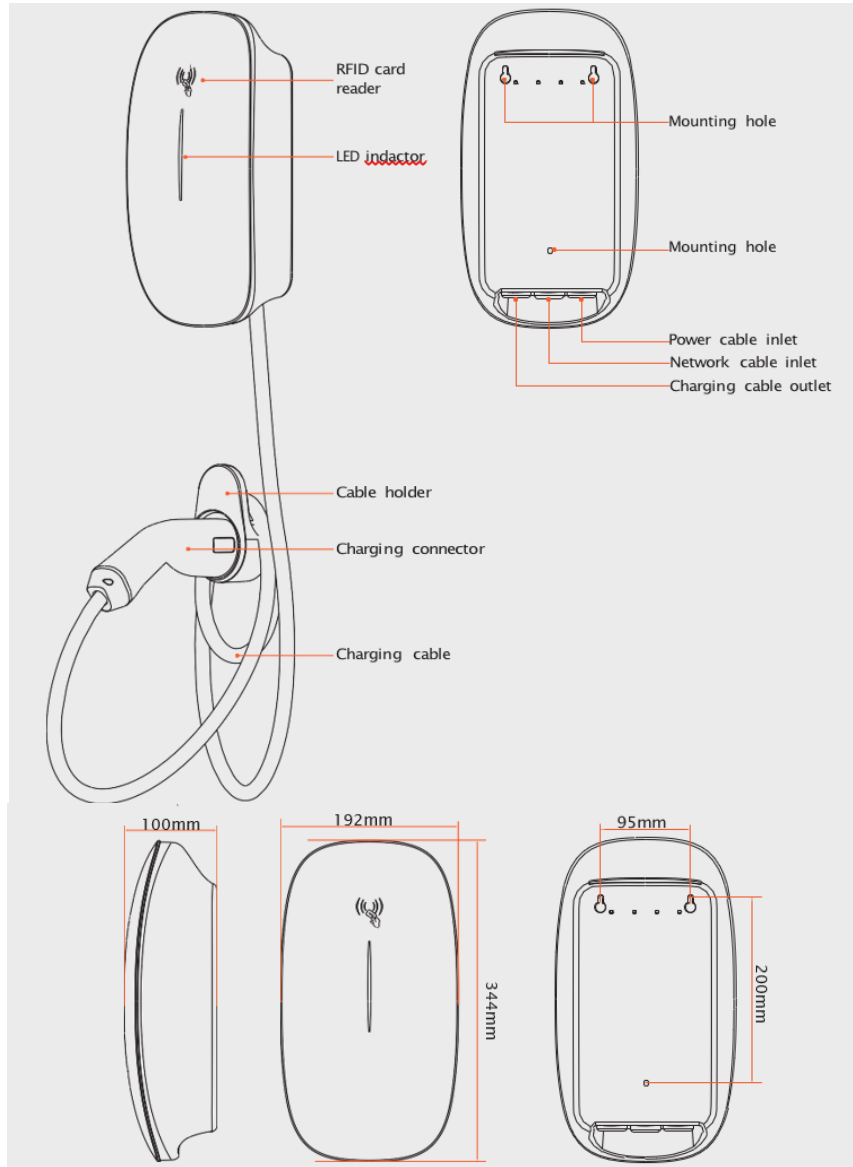

3.2. Model variant

Model No.	Rating	Connector
ZV1-7K-CARO-CAB	7kW	Type 2 Cable
ZV3-11K-CARO-CAB	11kW	Type 2 Cable



4. Technical Specification

TECHNICAL DATA	AC7000-AE-35	AC011K-AE-35
Input		
Power Supply	1P+N+PE	3P+N+PE
Rated Voltage	230V AC	400V AC
Rated Current	32A	16A
Frequency	50/60Hz	50/60Hz
Output		
Output Voltage	230V AC	400V AC
Maximum Current	32A	16A
Output Power	7kW	11kW
User Interface		
Charge Connector	Type 2 cable	
Cable Length	4m	
Housing Material	Plastic PC940	
LED Indicator	Green/Yellow/Red	
RFID Reader	Mifare ISO/IEC 14443	
Start Mode	Plug&Play/card RFID/App	
Communication		
WiFi	WiFi (2.5Ghz)	
Bluetooth	Yes	
Ethernet	Yes	
Protocol	OCPP 1.6 JSON	
Security and Safety		
RCD	30mA + 6mA DC detection	
Ingress Protection	IP65	
Impact Protection	IK10	
Electrical Protection	Over current protection, Residual current protection, Surge protection, Over/Under voltage protection, Over/Under frequency protection, Over temperature protection	
Certification	CE/CB/UKCA/EN303546	
Certification standard	IEC 61851-1:2019 IEC 62955:2018 IEC 61851-21-2:2018 IEC62196	
Warranty	2 years	
Environment		
Installation	Wall-mount/Pole-mount (Optional)	
Work Temperature	-30°C~+50°C	
Work Humidity	5%~95%	
Work Altitude	<2000m	
Package		
Product Dimension	344*201*100mm (A*L*P) Cable 344*201*135mm (A*L*P) Socket	
Package Dimension	440*340*240mm (A*L*P) Cable 400*250*210mm (A*L*P) Socket	
Net Weight	3.1kg	3.5kg
Gross Weight	3.6kg	4.1kg
Outer Package	Cardboard box	



1
Download the App and register.



2
Connect the charging cable to the vehicle.



3
Scan the QR code to start charging.



4
Stop charging from the App.

5. Installation



Danger

- DO NOT install the charging station near flammable materials.
- DO NOT install the charging station in an area where flammable or explosive materials are stored.

Before the installation, ensure that:

- ✓ The charger power is within the allowed load range of the place.
- ✓ Cables and RCBOs meet the installation and usage requirements.
- ✓ If the AC input power cable exposed to the outdoor environment is 3m or longer, consult the local installer. You are advised to install a surge protective device (SPD) at the upstream of the charger's RCBO.
- ✓ A network cable that is long enough is prepared if the charger is connected to a wired network.
- ✓ The installation area should be covered by a wireless network if the charger is connected to the network through WiFi.

5.1. Checks before installation

Checking the outer packaging

Packaging materials and components may be damaged during transport. Therefore, it is recommended to check the materials of the outer packaging before installing the charging station. Check the surface of the box for external damage such as holes or tears. If any type of damage is detected, do not open the box containing the charging station and contact the supplier and the courier as soon as possible.

It is also recommended that you check the contents of the packaging and make sure that they correspond to what was declared. If not, contact your dealer to have any missing parts sent to you.

Checking the product

After removing the charging station from its packaging, check that the product is intact and complete.

If any damage is found or components are missing, contact the supplier and transport company.

Contents of the packaging

No.	Part	Qty
1	 Charging station + cable	1
2	 Insulated Terminal	(*3) for single-phase (*5) for three-phase
3	 M4*32 Screw	6
4	 Wall Plugs	6)
5	 RFID activation card	2
6	 Dismounting Tool	1











7		Cable Holder	1
8		M4 Hex Key	1
9		Seal Cup	1
10		Cable clip	1
11		M3*12 screw	2
12		6 Pins terminal block	1
13		User Manual	1
14		Warranty	1

Table 2 – Package contents

5.1.1. Required Cable and Accessory







Before installation, you will need to prepare the following accessories and cables on your own:

	<ul style="list-style-type: none"> • To facilitate cabling, aluminium wires and solid copper wires are not recommended. • Ethernet cable, RJ45 connector, and RS485 cable are necessary solely for the implementation of their respective functions.
Attention	

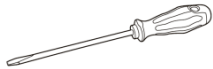
Item	Specification
Power cable	Operating current: 32A: Cross section area: $\geq 6\text{mm}^2$ Operating current: 16A: Cross section area: $\geq 2.5\text{mm}^2$
RJ45 connector	Standard
Ethernet cable	Cat 5e or higher, CSA: $0.2 \sim 0.25\text{mm}^2$
RCBO 1PH 7kW	2P RCBO, C40, 40 A, Type A, 30mA in compliance with local regulations.
RCBO 3PH 11kW	4P RCBO, C25, 25 A, Type A, 30mA in compliance with local regulations.
RS485 cable	22 to 24AWG shielded twisted pair

5.1.2. Installation tools

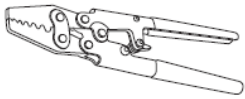
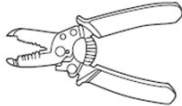
The following tools are required for the installation of the charging station and electrical connections; therefore, they must be prepared before installation.

No.	Tool	Function
1		Screwdriver To screw and unscrew screws for the various connections
2		Electric Drill To drill holes in the wall for fixing
3		Electric screw driver Fasten the screws
4		Wire cutter Cut the cable
5		Hydraulic clamp Clamp the RJ45 connector
6		Crimping pliers Clamp cord end terminal
7		Wire stripping tool To remove the outer sheath of the cables
8		Rubber hammer Drive the wall plugs into the wall







9		Multi-meter	To check the voltage and current values
10		Marker pen	To mark the wall for better fixing precision
11		Measuring tape	Measure the installation height
12		Level (> 180mm)	To make sure the bracket is level
13		ESD gloves	Protective clothing
14		Safety goggles	Protective clothing

Table 3 - Installation tools

	<ul style="list-style-type: none"> The tools are not included with the charger; they are commercially available.
Attention	

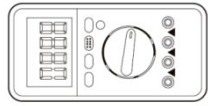
5.2. Installation Details

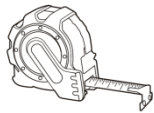
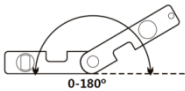
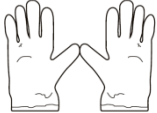
5.2.1. Installation position

Choose an appropriate installation location for the charging station. Follow the requirements below to determine the installation position.

The installation location chosen should allow easy access to the charging station for normal operation and maintenance.

For safety reasons, ZCS and/or its authorised partners may not perform repairs/maintenance or move the chargers from and to the ground if they are installed at a height of more than 180 cm. Stations installed at higher heights must be moved to the ground before they can be repaired or serviced.

5.2.2. Movement of the charger

- 1) Open the packaging and remove the polystyrene protection cover, insert your hands into the slots and take hold of the device;
- 2) Lift the charging station from its packing box and move it to the installation position, then remove the polystyrene protections.

	<ul style="list-style-type: none"> • To prevent damage and personal injury, hold the device securely when moving as it is a heavy piece of equipment • Always position the device horizontally • Please note that the installation drawings are for illustrative purpose only, and the actual installation should be based on the physical charger. • Please note that the internal structure of the charger may differ based on the supported communication methods.
Attention	

5.3. Opening

Step1: Remove the two screws at the bottom

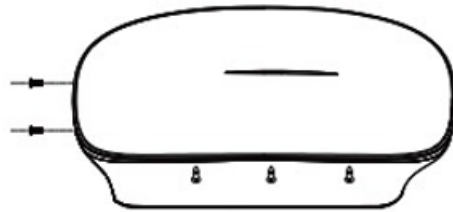

Step2: Use the dismantling tool to pry the marked points (1~3) along the edge in order

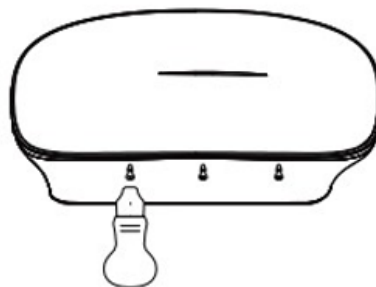

Step3: Pry the marked points (1~3) along the edge in order

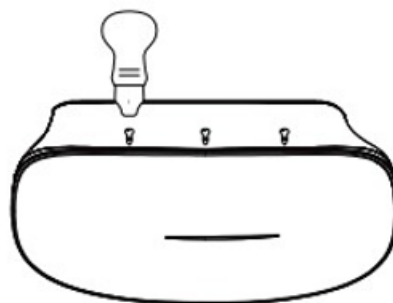

Step4: Finish opening the external cover

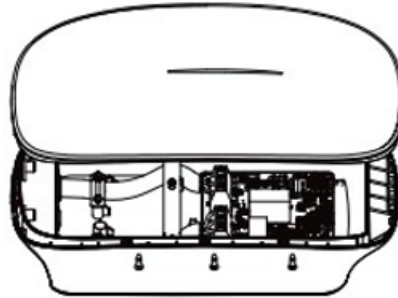

5.4. Install wall mounting screw:

- 1) Place the positioning diagram on the wall, aligning it properly.
- 2) Make marks on the wall corresponding to the holes indicated on the diagram.
- 3) Drill three holes, each 40mm deep, at the marked spots.
- 4) Drive three wall plugs into the drilled holes, ensuring they are flush with the wall surface.
- 5) Drive two wall mounting screws into the upper two wall plugs, leaving a 5mm gap between the screw heads and the wall surface to form hooks.

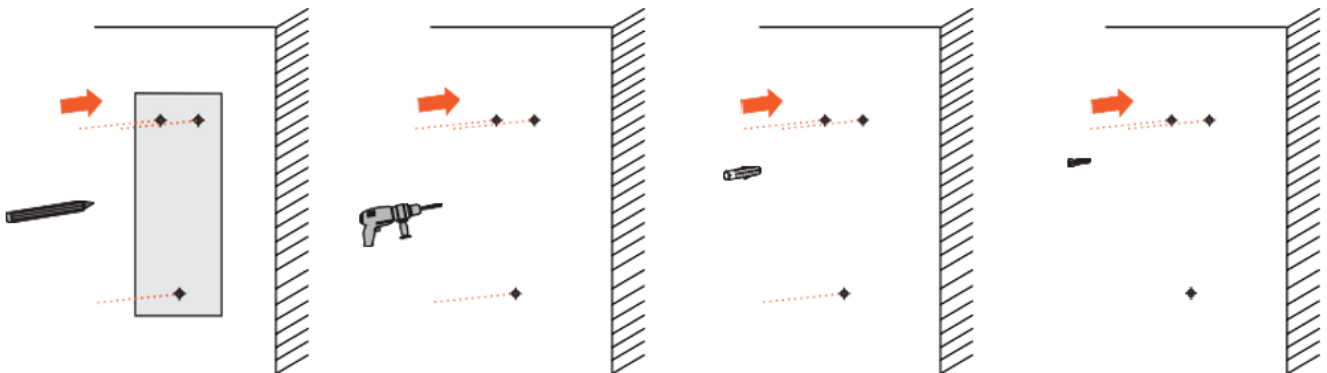

5.5. Hang the enclosure on the screws

- 1) Position the enclosure on the wall mounting screws by aligning and inserting the protruding screws into the mounting holes on the back of the enclosure.
- 2) Seal the middle mounting hole with the seal cap.

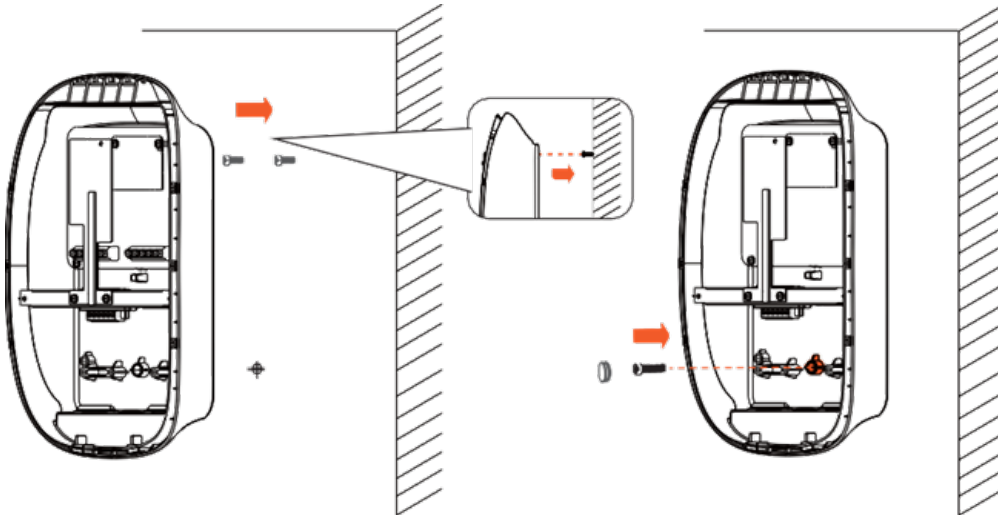

5.6. Connect power cable

- 1) Use a wire stripper to stripe the power cable, exposing a 12mm length of conductors.
- 2) Warp the exposed conductors with wire ferrules.
- 3) Use a cable crimping tool to securely crimp the wire ferrules.
- 4) Connect the crimped end into the terminal block.
- 5) Use a cable clip to secure the power cable in place.

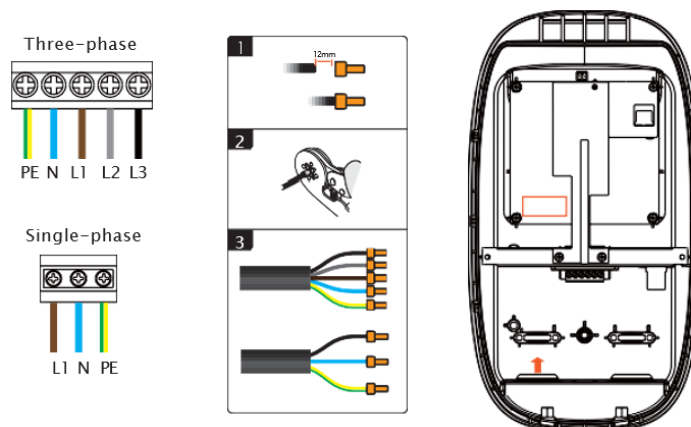

5.7. Connect Ethernet cable

- 1) Use a wire stripper to remove the outer insulation, exposing the inner wires.
- 2) Arrange the wires in the correct order (T568A /T568B) and insert them into the RJ45 connector.
- 3) Use a crimping tool to secure the RJ45 connector into the network port as shown below.

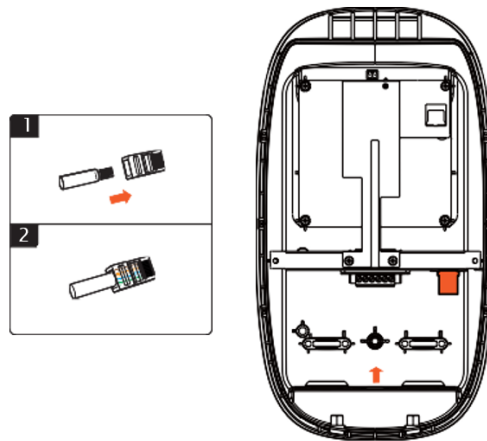

5.8. Connect RS485 cable & CT

The locations of the RS-485 and CT ports remain consistent regardless of whether the charger is single-phase or three-phase; their variations in positioning are primarily dictated by the distinct communication methods employed.



Attention

- **The charger body is marked with labels for the RS485 and CT ports; please refer to these labels and follow the provided instructions to properly connect the wires**

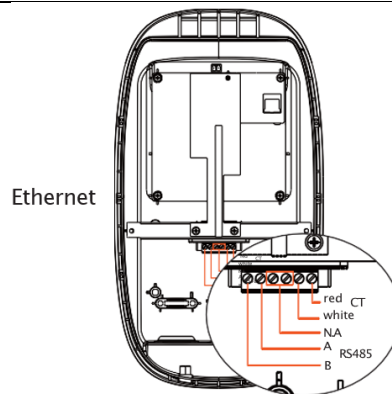

5.9. Secure the enclosure and faceplate of the charger

- 1) Tighten the wall mounting screw into the middle hole to firmly secure the enclosure to the wall.
- 2) Mount the faceplate onto the enclosure and secure it in place.
- 3) Installation completed.

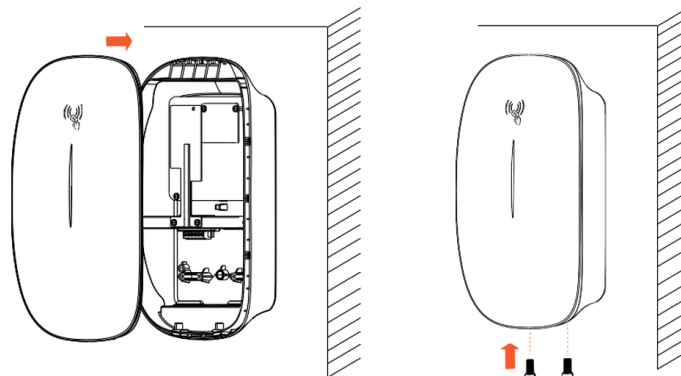

6. Operation and Configuration

6.1. Charging Operation - Plug & Charge

Standby

A green indicator flashing slowly for 1s at 3-sec intervals indicates the charger is ready to use.



Plug in

Plug the charging connector into your EV's charging socket.

A green indicator flashing for 200ms at 1-sec intervals indicates the charging connector is plugged in.



Charging

A green indicator breathing at 1-sec intervals indicates the charging is in progress.



Fully charged

Solid green light indicates the EV is fully charged.



Unplug

Unplug the charging connector.

Return to standby mode after the charging has finished



6.2. Configuration

After completing the wiring of the dynamic load balancing, you need to configure in the software interface such as in App or in AP mode.

6.2.1. By APP

Swipe down on the charging page.

Tap "Charging Mode", and select "Load balance" to make the configuration.

- ✓ CT ratio: 150:5.
- ✓ Max load current: Labelled on the property's consumer unit.

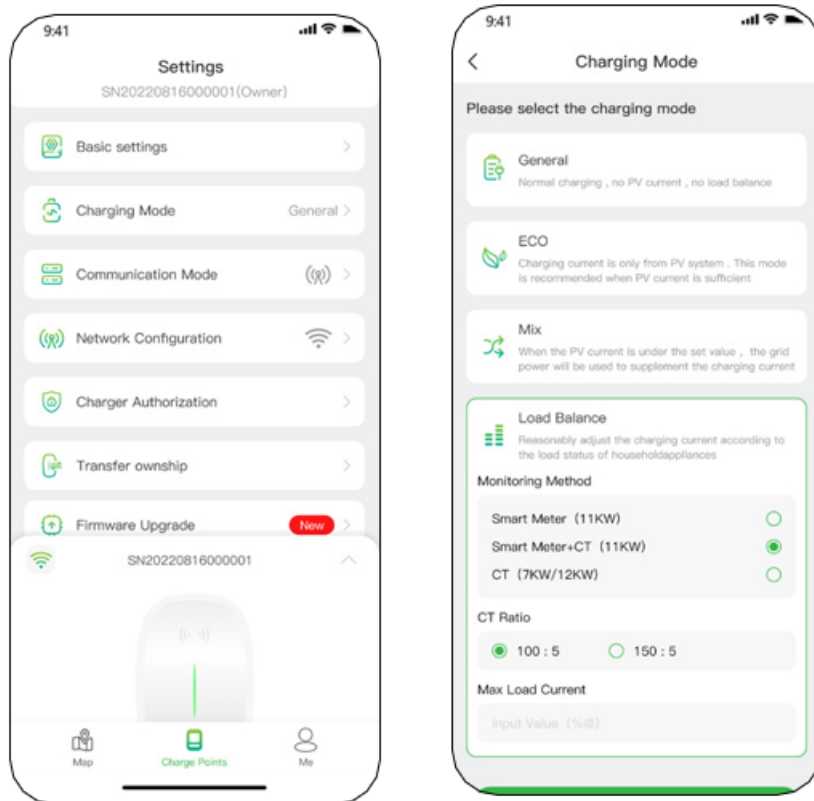

6.2.2. By AP Mode

The Hotspot interface is intended for the local configuration of the charger. A smartphone is needed to connect the charger hotspot.

You can initiate the Hotspot interface by following the instructions.

6.2.2.1. Preparation

Activate the Hotspot:

Activate the hotspot of the charger by restarting the power.

The hotspot of the charger remains available for 15mins since charger reboot.



Connect to Charger Hotspot:

Turn on the smartphone Wi-Fi, and connect the hotspot of the charger. If unable to connect, try using Airplane mode.

The name of the hotspot Wi-Fi starts with the charger SN number, i.e. "SN..." .

The password is admin123.



6.2.2.2. Login

Open the browser on your smartphone and enter 192.168.4.1 in the address bar.

Log in using the four-digit PIN code located on the last page of the manual. After login, the function menu will be displayed.

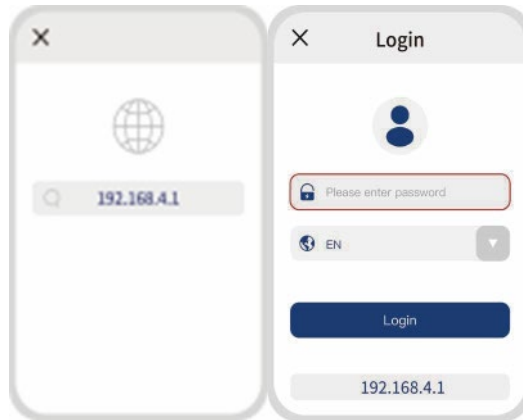

6.2.2.3. Configuration:

Newwork Configuration

Click "Network setting", you'll see the following:

1. Communication types

The default type will be Wi-Fi. Other options include Ethernet.

2. Wi-Fi name

Select the Wi-Fi or enter the Wi-Fi name and enter the password.

3. Server address

The default address will be shown here. You can also enter a new address.

4. Grid type

The default Grid type will be shown here. If the default is wrong, click the dropdown button and select the right type from IT / TT / TN.

Notice: When the configuration is successfully done, you need to reconnect the smartphone to the charger hotspot. Then go back to the web page. It will automatically jump to the login page. Login again to start charging setting.

Charging Setting

Click "Charger setting" to configure the charger.

1. Load balance

The function of Load Balance is ONLY available when power meter or CT is installed.

If both power meter and CT are installed, both ratio of transformation and maximum current can be set properly according to the CT specification.

If only one installed, either power meter or CT, ONLY maximum current can be set.

2. Charging mode switch

Click “mode switch” and choose the “Network mode” or “Plug&Charge mode”. Then click “Confirm” to complete mode switching.

2. Charging current setting

The maximum charging current can be set (within the specified range).

6.3. Charging APP

6.3.1. App Introduction

Evcharge App, your companion app for managing your charger.
Designed with user-friendly interface, Evcharge offers seamless integration with your charging needs.

 Attention	<ul style="list-style-type: none">• If you are an installer, you can download and install Evcharge App, and after completing all necessary configurations, you can transfer the ownership to the user.• The user then simply installs the App and log in to easily control the charging process with the App.
---	--

6.3.2. Download & Installation

For the use of the monitoring portal, please refer to the dedicated documentation on the website <http://www.zcsazzurro.com/>.

In the section on charging stations see the document "User Manual Evcharge Portal"

In addition, for the creation of the account on the new portal: <https://cloud.evcharge.com/> please email us the following data so that we can activate them and properly configure the new account:

- company name or how to call the account
- email with which to register

Send us this data by opening a ticket from our website <http://www.zcsazzurro.com> in the section Support/Request assistance and commercial info.

Once you have created your account, you will receive a notification email from notification@evcharge.com with your account password.



Evcharge Download
(IOS&Android)

6.3.3. Sign Up and Log In

✓ **Account creation:**

Open the app and tap "Sign Up" to create a new account. Enter your Email address, set a password and confirm your details.

✓ **Login:**

To login, enter your email and password.

✓ **Select Scenario:**

Select the second one.

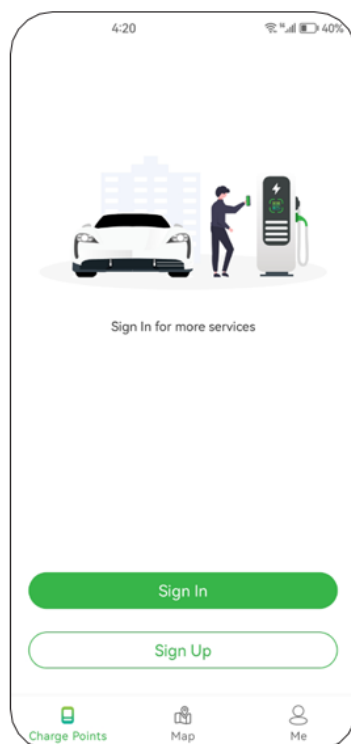

6.3.4. Bind Charger to App

- ✓ Turn on Bluetooth, Wi-Fi and GPS in your mobile phone.
- ✓ Add the charger through the provided methods.
- ✓ Select the brand of your charger.

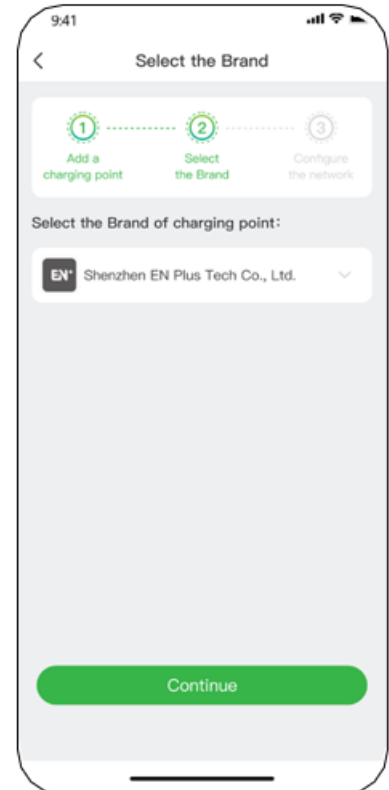
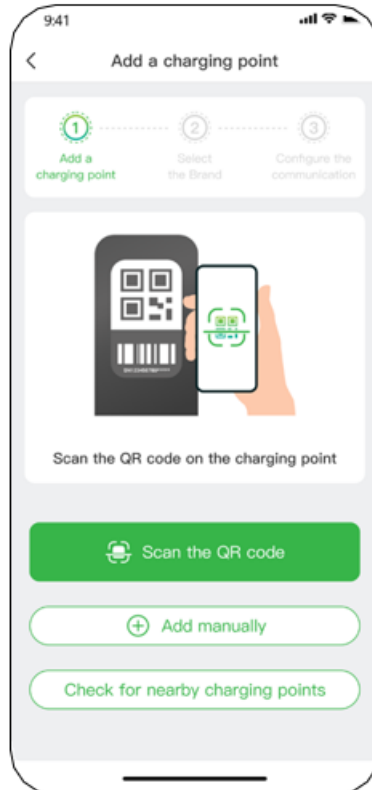
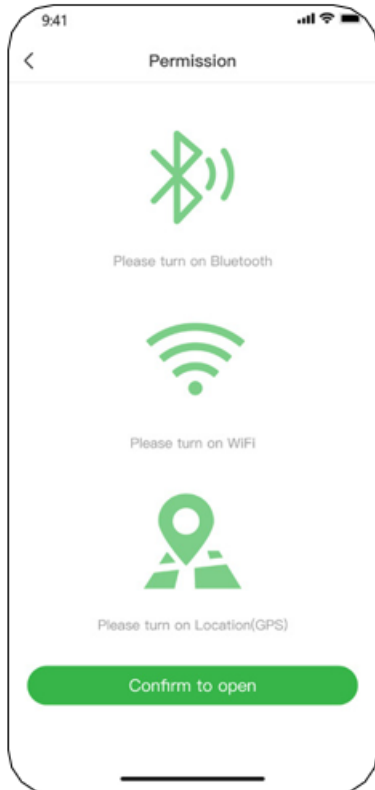

6.3.5. Select Communication Mode

- ✓ The communication modes determines the charging modes you use to charge EV.
- ✓ If Bluetooth mode and plug to charge mode are selected, it will jump to the charging control page directly.
- ✓ If online mode is selected, you need to configure network (Wi-Fi or Ethernet) for the charger.

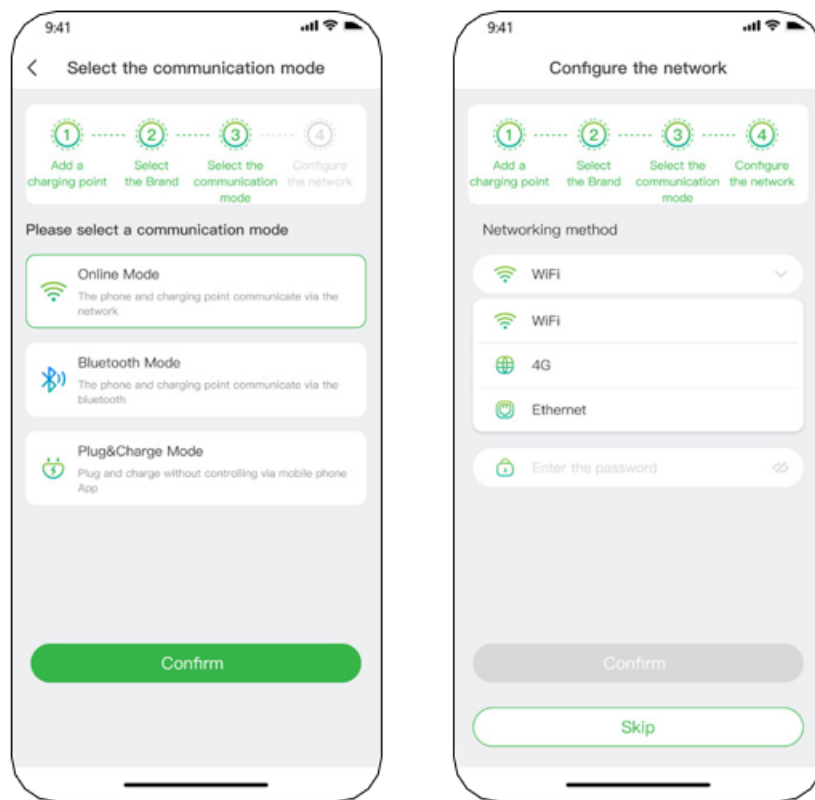

6.3.6. Set Maximum Charging Current

The main fuse or circuit breaker in the property's consumer unit should be labelled to state the maximum load. It is imperative that the maximum charging current is configured in such a way that the property's power supply remains uninterrupted, even at peak usage, while ensuring that all other household appliances continue to function without disruption.

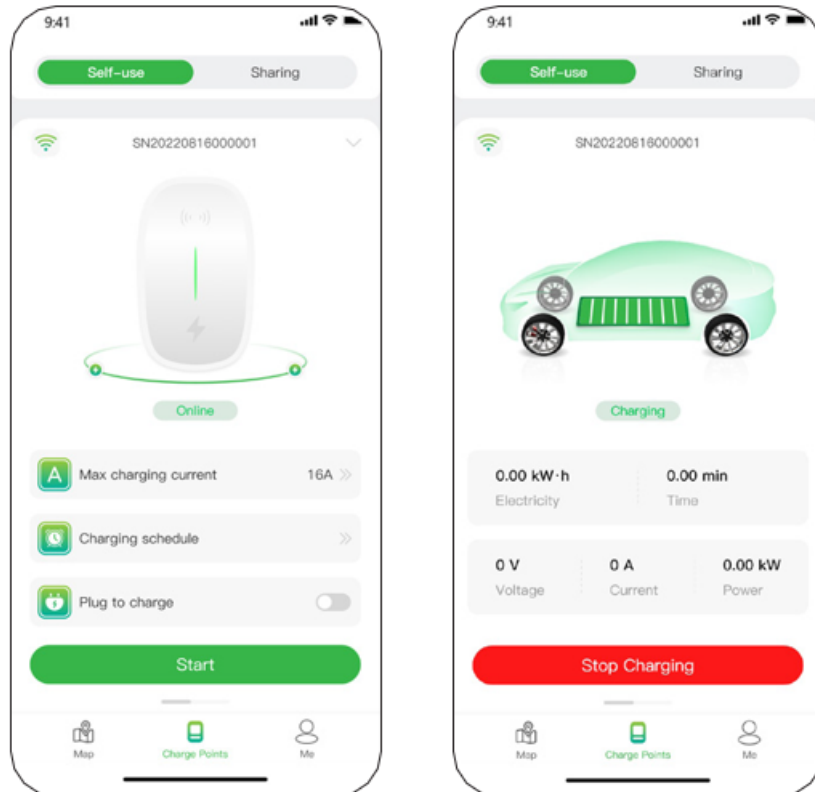

6.3.7. Transfer Ownership to End User

If you are an installer, after completing the above step and no other functions such as load balancing, PV charging are required, you can use the "Transfer Ownership" feature within the APP to transfer account control to the user. This way, the user can easily control charging without any additional configuration through the APP.

1. wipe down on the charging page.
2. Tap "Transfer ownership".
3. Enter the email address of the receiver.

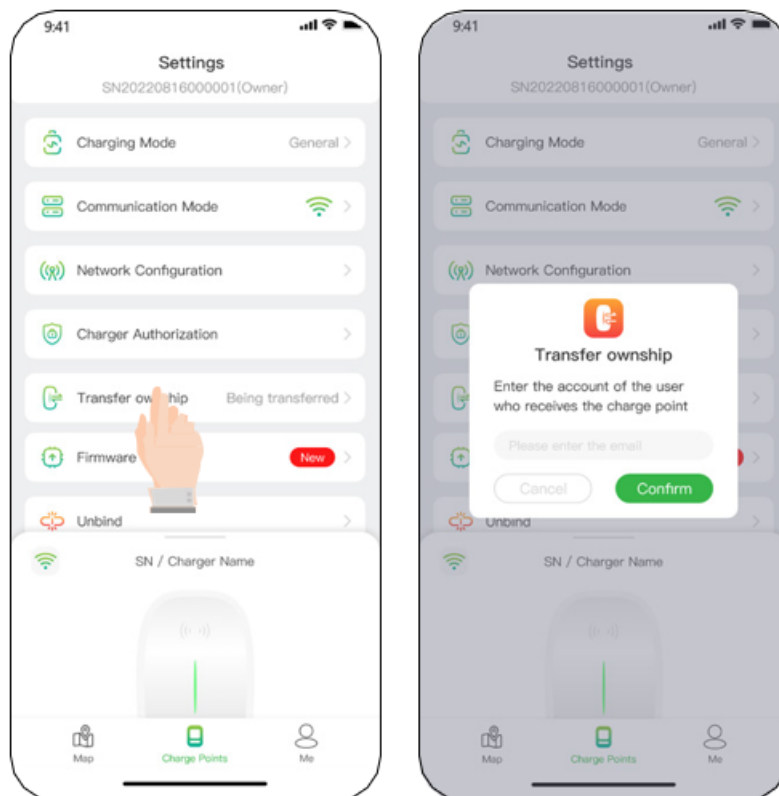

6.3.8. Charging Operation

Plug to charge

1. Turn on the "plug to charge" toggle.
2. Plug the charging connector in, and the indicator
3. flashes green quickly for five times.
4. The indicator gradually brightens, then gradually dims in green while charging in progress.
5. The charging session will be stopped by EV side upon it is fully charged.

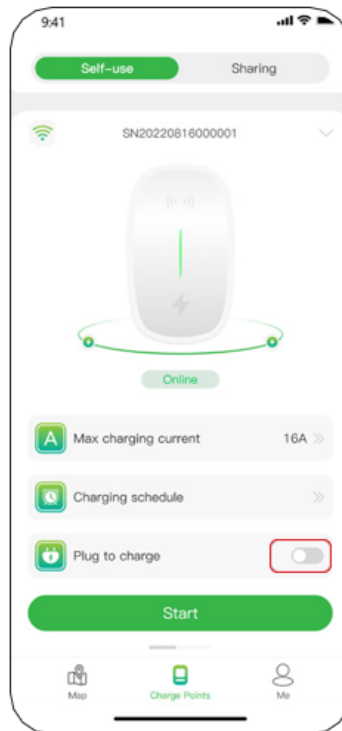

Control charging via App

Controlling charging process via App is convenient, with two options available: Ethernet, or Wi-Fi, or via Bluetooth.



Attention

- **For the Bluetooth, it's important to maintain your phone within the Bluetooth communication range of charger to ensure a reliable and stable connection.**

- ✓ Plug the charging connector in, and The indicator flashes green quickly for five times.
- ✓ Tap "Start" button in the screen, and the indicator gradually brightens, then gradually dims in green while charging in progress.
- ✓ The charging will be stopped automatically as EV is fully charged, or you can tap "Stop" button to stop charging.

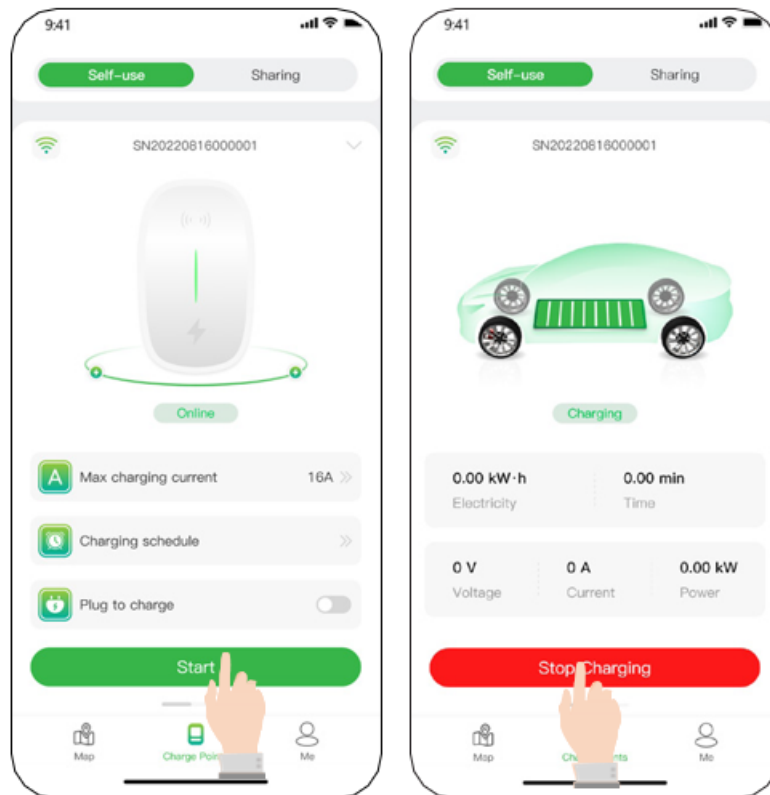

Scheduled charging

Scheduled charging for EVs lets you set specific times to charge your electric vehicle, helping you save on electricity costs and reduce strain on the grid.

- ✓ Plug the charging connector in, and the indicator flashes green quickly for five times.
- ✓ Tap "Charging schedule" to create a schedule.
- ✓ The charging will start automatically upon reaching the specified time.

- ✓ The charging will be stopped automatically as EV is fully charged, or you can tap "Stop" button to stop charging.

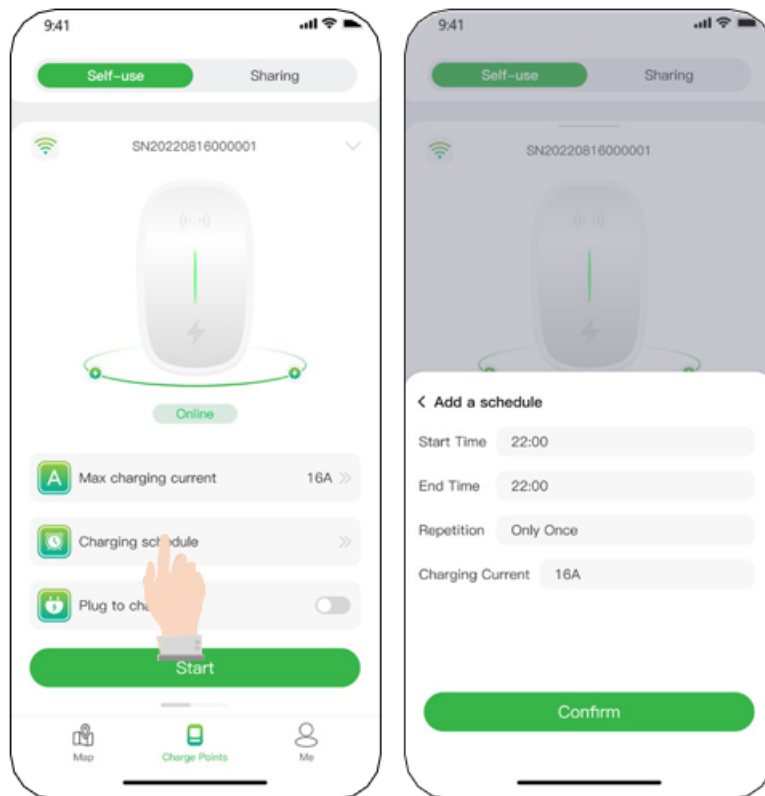

Charging by swiping card

- ✓ Plug the charging connector in, and the indicator flashes green quickly for five times.
- ✓ Swipe card, and the indicator flashes yellow quickly for up to five times.
- ✓ During charging, the indicator gradually brightens, then gradually dims in green.
- ✓ Swipe card and unplug to the connector.

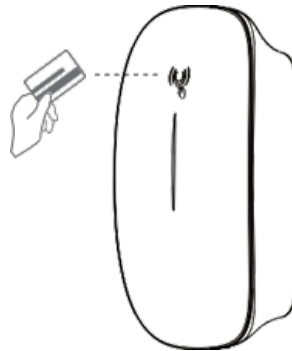

7. Dynamic Load Balancing

In the single charger scenario, the charger supports dynamic load balancing. By integrating a Current Transformer (CT) or a Meter or a meter & three CTs, the charger can dynamically adjust its charging power to ensure that the electrical system remains within the capacity limits and not overload.

	<ul style="list-style-type: none"> Current Transformers (CT) and meter are sold separately. If you need these items, please contact technical support team. This is essential because a thorough commissioning is required to ensure they work seamlessly with the charger to achieve the desired functionality.
Attention	

Here are the available solutions for your reference:

Product	Scenario	Associated equipment
ZV1-7K-CARO-CAB	<ol style="list-style-type: none"> Total power Load in consumer unit $\leq 50A$ The distance between CT and Charger $\leq 15 M$ 	CT*1
ZV3-11K-CARO-CAB	<ol style="list-style-type: none"> Total power Load in consumer unit $\leq 80A$ The distance between meter and Charger $\leq 100 M$ 	Meter *1
	<ol style="list-style-type: none"> Total power Load in consumer unit $\leq 150A$ The distance between meter and Charger $\leq 100 M$ 	Meter*1 CT *3

7.1. Wiring for Dynamic Load Balancing

Based on the solutions shown above, for the hardware wiring of the dynamic load balancing.

7.1.1. Introduction Load Balancing

This guide provides a step-by-step implementation process for the Dynamic Load Balancing solution, enabling efficient

energy distribution for Electric Vehicle (EV) chargers.

We will introduce the implementation of load balancing from five key aspects:

- ✓ The charger supporting load balancing in our company
- ✓ The required accessories and specifications
- ✓ The scenarios where the load balancing is applicable.
- ✓ The hardware wiring
- ✓ The software configuration

7.1.2. Supported EV Chargers



Our Dynamic Load Balancing solution is compatible with specific models of EV chargers:

- ✓ ZV1-7K-CARO-CAB
- ✓ ZV3-11K-CARO-CAB

7.1.3. Applicable Scenarios and Required Accessories

Our solution is designed to provide you with a customized load balancing solution based on the total current capacity of your home and the power of your charger.

Solution No.	Required accessories	Phase of charger	Total Current	Photo
ZVM-CARO-TA	One CT	Single phase	Total current < 50A Charger connected to the CT directly	

ZVM-CARO-METER-01	One meter	Three phases	Total current < 80A Charger connected to the meter via Modbus	
ZVM-CARO-METER-02	One meter Three current transformers	Three phases	Total current < 150A The meter gets the current via three CTs, and the charegr connected to meter via modbus	

7.1.4. Specifications

Model No.	ZVM-CARO-TA	ZVM-CARO-METER-01	ZVM-CARO-MATAER-02
Voltage range		3×57.7/100V - 3×260/450V	
Consumption		<10VA(Single phase)	<10VA(Single phase)
Impedance		> 2M Ω	> 2M Ω
Accuracy class		Error ±0.2%	Error ±0.2%
Input current		3x1(6)A	3x10(150)A
Frequency		45~65Hz, error±0.2%	
Energy		Active energy (accuracy class:0.5)	

CT clamps		No	Yes
Interface and communication protocol		RS485: Modbus RTU	
Range of communication address		Modbus RTU:1~245	
Baud rate		1200bps~38400 bps	
Working temperature		-25°C ~ +55°C	
Working humidity		5%~95%	
Working altitude		<2000m	
Warranty		2 years	

7.1.5. Hardware Wiring

Caro_Single phase

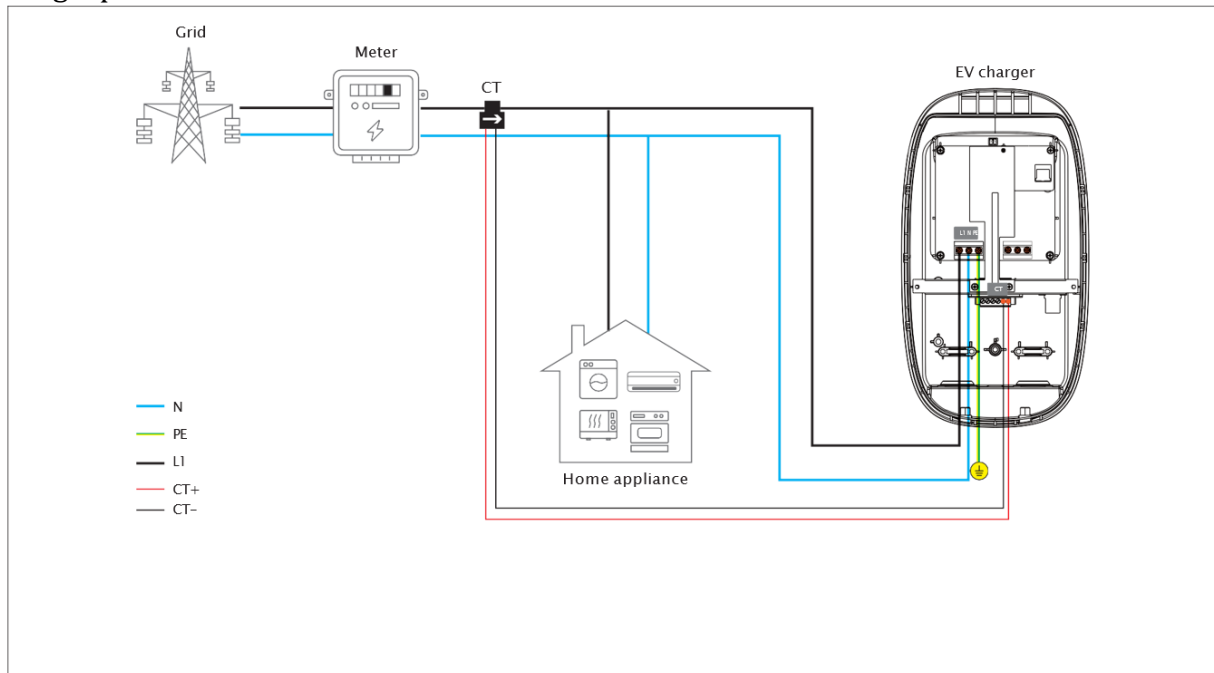

Caro_Three phases_Meter

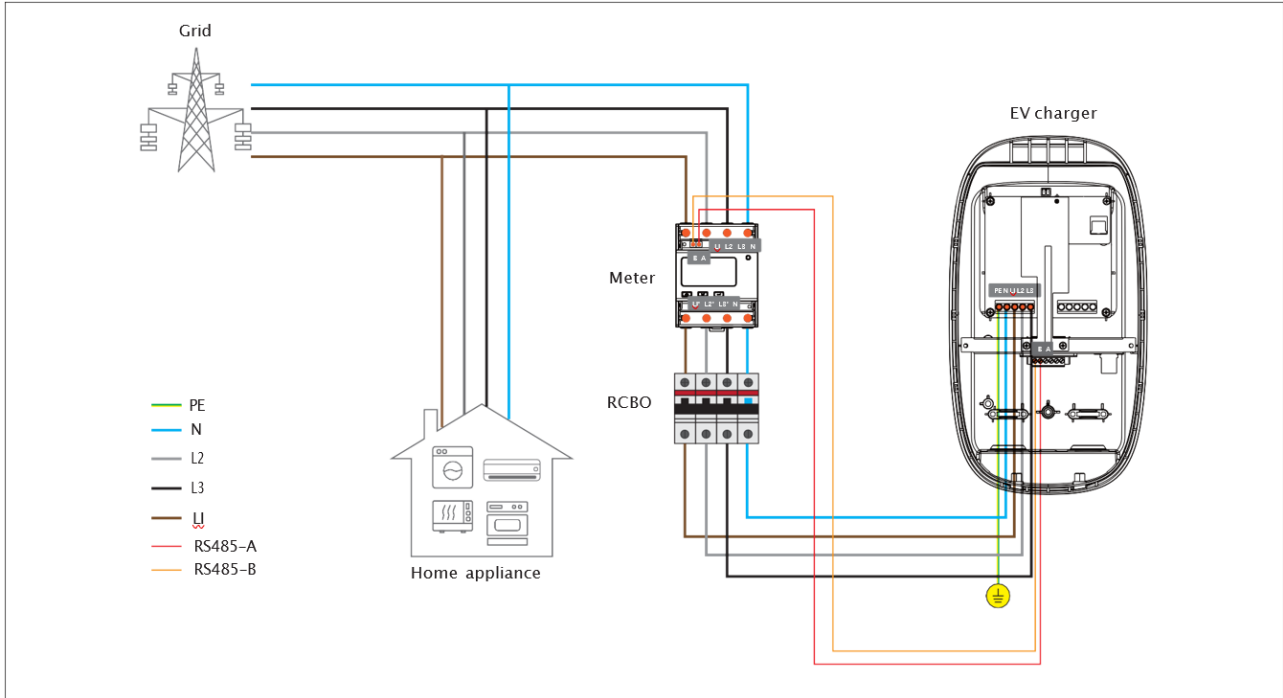

Caro_Three phases_Meter + CT

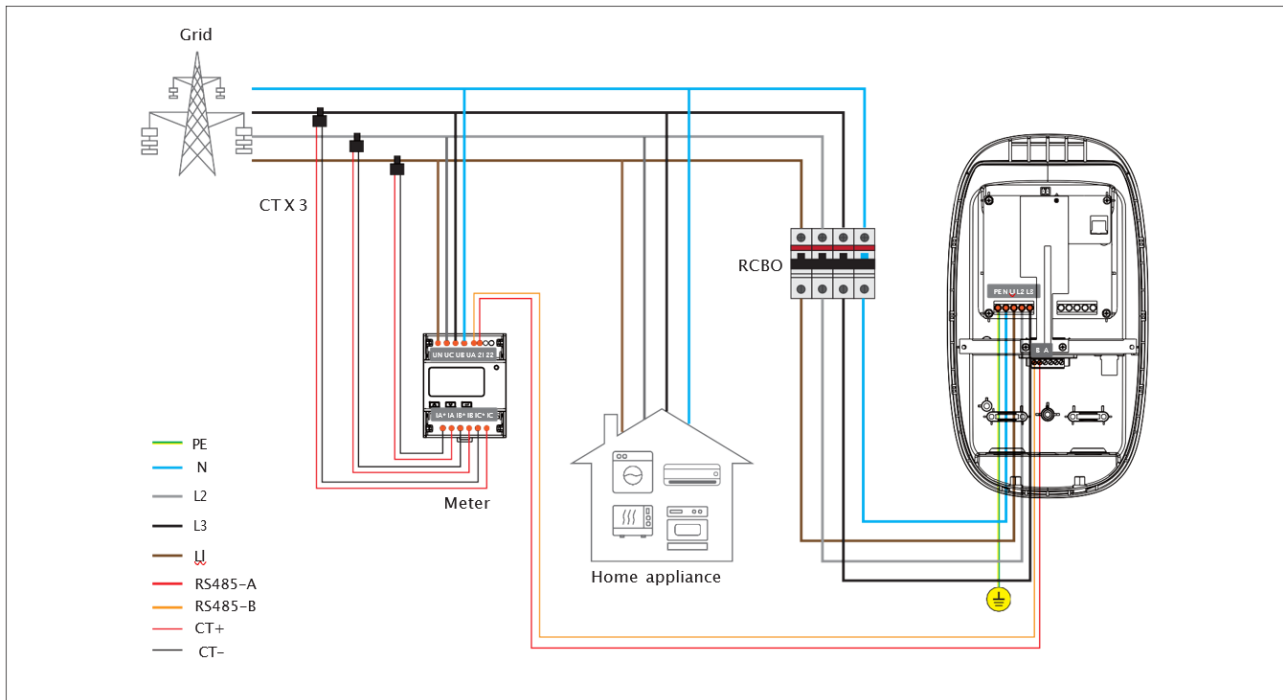

7.2. Software configuration

7.2.1. Configured via APP

After completing the hardware wiring, you also need to configure it within the APP.

Accessing Settings:

Scroll down in the charging page of Evchargeo app, find "Charging mode", as shown:

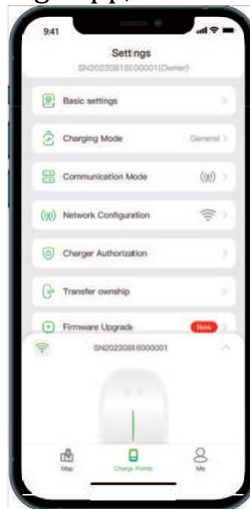

Choose the monitoring method based on the accessories you choose to achieving load balancing.

If you opt for the "Smart Meter + CT" configuration, ensure that the CT ratio is set to 150:5 for proper functionality.

Regarding "Max Load Current," this refers to the maximum current threshold that your home's electrical system can handle without tripping. It's the limit beyond which the circuit breaker will activate to prevent overloads.

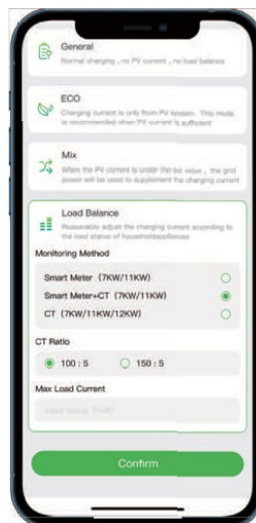

For the use of the monitoring portal, please refer to the dedicated documentation on the website <http://www.zcsazzurro.com/>.

In the section on charging stations see the document "User Manual Evchargeo Portal"

7.2.2. Configured via AP mode

AP Mode, also known as Access Point Mode, is a versatile wireless networking feature that enables devices like EV charger to function as Wi-Fi access points, establishing a dedicated hotspot. Users can effortlessly connect their smartphones or other mobile devices to this hotspot and manage the device through a web interface by navigating to a designated IP address, such as 192.168.4.1. This setup facilitates remote monitoring and configuration of the device, eliminating the need for physical interaction and ensuring a user-friendly and secure wireless management experience.

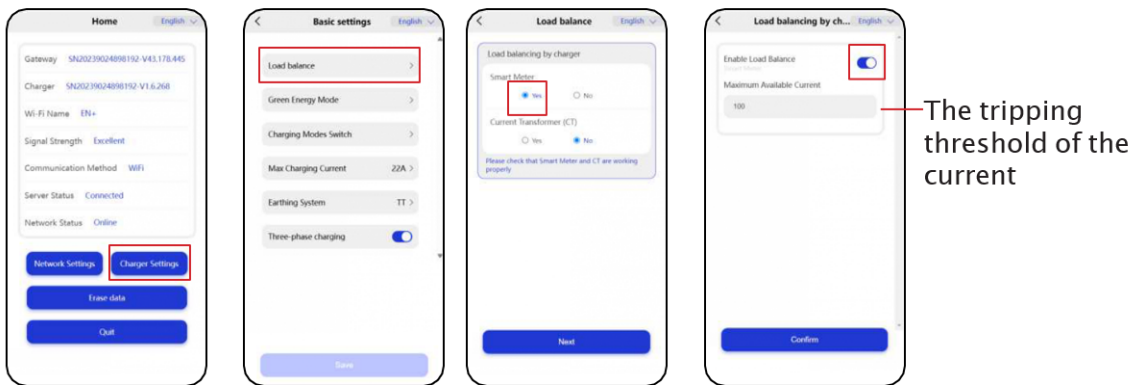

8. Indicator

Indicator color	EV charger status	Indicator status
Green	Standby	Cycle: Slow flashing: on for 1s, then off for 3s.
	Charging initiated, awaiting vehicle response	Cycle: Rapid flashing: on for 200ms, then off for 1000ms, followed by a 3000ms off.
	Charging connector plugged in, ready for Charging	Cycle: Rapid flashing: on for 200ms, then off for 1000ms, followed by a 3000ms off.
	Charging in progress	Cycle: gradually brightens, then gradually dims, on for 1s, off for 1s.



	Charging completed	Steady green.
Yellow	No Network/Not Connected to Server	Cycle: The green light is on for 1s, followed by the yellow light on for 1s, then off for 3s.
	Bluetooth lock	Cycle: Flashing: on for 4s, then off for 1s.
	Scheduled charging in Bluetooth mode	Cycle: Rapid flashing: on for 2s, then off for 2s.
	Insufficient Power Allocated, Pausing Charging	Cycle: Rapid flashing: on for 200ms, then off for 1000ms, followed by a 3000ms off.
	Card Identified Successfully	Cycle: Rapid flashing: The indicator light is on for 100ms, then off for 100ms, with a maximum of 5 repetitions.
	Charger Reserved (Occupied)	Rapid flashing: on for 2s, then off for 2s
	Alarm	Steady yellow.
White	Program is upgrading	Cycle: Rapid flashing: on for 200ms, then off for 1000ms, this pattern repeats five times, followed by a 3000ms off.
	Power-On Self-Test	Cycle: Breathing light: Gradually brightens, then gradually dims, on for 1s, off for 1s.
Red	Faulty	Steady red, flashes red, alternating red & yellow

9. Troubleshooting and maintenance

This section contains information and procedures on how to troubleshoot any faults and errors that may occur during operation of the charging station.

If you have any problems please follow these steps:

- 1) Check the warning messages and error codes on the information panel of the device. Record them before carrying out any further operation.
- 2) If the charging station does not display any errors, perform the following checks:
 - Is the device located in a clean, dry and properly ventilated place?
 - Are the cables correctly sized and as short as possible?
 - Are the connections in good condition?
 - Are the configuration settings correct for the type of installation?

9.1. Troubleshooting Common Faults

Information on the event list:

Symptom	Possible Cause	Solution
The indicator is off	The upstream input power is abnormal.	Check the upstream input power cable
	The upstream RCBO is abnormal	Check the upstream RCBO. If the RCBO is faulty, replace it
	The AC power cable is abnormal (damaged, loosely connected, or other connection faults).	Check the cable
	The charger is faulty.	Contact technical support
The indicator is steady red or flashes red	The AC input power cable of the charger is loose, damaged, or incorrectly connected to the power distribution box.	Reconnect the cable as required
	The charger socket is faulty.	Contact technical support.
	The charging connector cable is damaged or abnormal.	Replace the charging connector
	There is a risk of current leakage.	Switch off the upstream RCBO and power on the charger 5 seconds later

	Other causes	If the fault persists after the restart, contact technical support
The indicator flashes red and yellow alternatively	The voltage or frequency of the grid is unstable	Please try again 10 minutes later

Note: If the above problems cannot be resolved, contact Zucchetti Centro Sistemi Spa

9.2. Troubleshooting Technical Faults

Information on the event list:

Indicator color	EV charger status	Indicator status	Solution
Red	Relay adhesion	Steady red	Please contact after-sales
	Leakage current fault	Cycle: on for 500ms, then off for 500ms once, followed by 3s off.	
	CP fault	Cycle: on for 500ms, then off for 500ms, twice; followed by 3s off.	
	Overcurrent fault	Cycle: on for 500ms, then off for 500ms, 3 times; followed by 3s off.	
	Reverse polarity fault	Cycle: on for 500ms, then off for 500ms, 4 times; followed by 3s off.	
	Leakage current loop anomaly (self-check)	Cycle: on for 500ms, then off for 500ms, 5 times; followed by 3s off.	
	Input terminal overheat fault	Cycle: on for 500ms, then off for 500ms, 6 times; followed by 3s off.	
	Relay Overheat	Cycle: on for 500ms, then off for 500ms, 7 times; followed by 3s off.	
Red + Yellow	Undervoltage fault	Cycle: on for 500ms, then off for 500ms, 9 times; followed by 3s off.	Please try again 10 minutes later
	Overvoltage fault		
	Overfrequency fault	Cycle: yellow on for 2s, followed by the red flashing once (on for 500ms, off for 500ms), then 3s off.	
	Underfrequency fault		

	Smart meter communication failure	Yellow on for 2s, followed by the red flashing 4 times (on for 500ms, off for 500ms), then 3s off.	Please contact after- sales
	Current transformer (CT) anomaly	Yellow on for 2s, followed by the red flashing 5 times (on for 500ms, off for 500ms), then 3s off.	
Red + Yellow	Charging connector lock anomaly	Yellow on for 2s, followed by the red flashing 6 times (on for 500ms, off for 500ms), then 3s off.	Please contact after- sales
	Charging connector current anomaly	Yellow on for 2s, followed by the red flashing 7 times (on for 500ms, off for 500ms), then 3s off.	
White	BOOT security verification failed or security chip is malfunctioning	Flashing white : on for 200ms, then off for 1000ms twice, followed by 5000ms off.	
	The charger in a Disabled state	Steady white	

9.3. Maintenance

Chargers do not need special maintenance. You are advised to check and clean the enclosure of the charger and accessories such as the charging connector every six months.

Check whether the charger and cables are damaged.

Use a dry cloth to clean the surface of the charger. Do not spray water directly on the charger.

	<ul style="list-style-type: none"> Do not use corrosive cleaners, glass cleaners, or organic solvents.
Attention	

No.	Item	Operating process
1	Keep the charger clean.	Use a cloth to clean the charger surface. If there is any damage or dirt on the vehicle connector, charging cable, or vehicle connector holder, please contact customer service immediately.

2	Keep the charger intact.	Do not hit or press hard on the case. If the case is damaged, please contact customer service.
3	Avoid letting moisture or water enter the charger.	If there is water or moisture inside the charger, you must immediately switch off the electricity supply to avoid immediate danger. Please notify your maintenance professional before continuing to use the charger.
4	Avoid charger rusted.	Keep the charger away from dangerous substances such as flammable gases and corrosive materials.

9.4. Storage and Transportation

Chargers should be transported in the original packages. Do not place other objects on the top of the charger.

Before transportation, store the product in a clean, dry, and well-ventilated place with a relative humidity of not more than 80% and free from corrosive gases.

The environmental specifications for storage and transportation shall not go beyond those specified in the Technical Specifications.

9.5. Disassembly

Only authorized and qualified electricians are allowed to disassemble the product.

Power off the charger before disassembling it. Disassemble a charger in the reverse order of installation.

9.6. Disposal/Scrapping

The product should be disposed of at recycling points for electronic equipment. Dispose of the product in a correct and environmental friendly manner in compliance with local laws and regulations.

Electronic devices cannot be disposed of as household waste.



10. Warranty

Zucchetti Centro Sistemi SpA provides a warranty of 2 years from the date of installation of the charging station, subject to registration on the website

<https://www.zcsazzurro.com/it/estensione-garanzia>. During the warranty period, Zucchetti Centro Sistemi S.p.A. guarantees the normal operation of the charging station.

If the device is defective or faulty during the warranty period, contact your installer or supplier. If the fault falls within the responsibility of the manufacturer, Zucchetti Centro Sistemi S.p.A. will provide service and maintenance free of charge.

Warranty exclusions:

- Normal wear and tear.
- Damage or failure caused by unauthorized upgrades conducted by a customer.
- Damage or failure caused by external factors such as fire, flood, abnormal voltage, other natural disasters, and secondary disasters.
- Damage or failure caused by improper handling of the charger, such as impact from a fall and careless transportation after purchase.
- Damage or failure caused by a customer not following the user manual.
- Damage or failure caused by non-equipment factors like human error by a non-authorized individual carrying out maintenance.
- Unauthorized repairs will render the limited warranty void.
- Damage or failure caused by external factors such as power grid malfunctions.

Limitation of liability:

We have compiled this document to the best of our knowledge but cannot guarantee that all information provided is error-free, nor will we accept liability in this respect.

To the maximum extent permissible under local applicable law, we hereby disclaim any and all indirect, incidental, special and consequential damages arising out of or relating to the AC Charger, including, but not limited to, loss of time, loss of income, loss of use, loss of personal or commercial property, inconvenience or aggravation, emotional distress or harm, commercial loss (including but not limited to lost profits or earnings), incidental charges such as telephone calls, facsimile transmissions, and mailing expenses. To the maximum extent permissible under local applicable law, we will not be liable for any direct damages in an amount that exceeds the market value of the AC Charger at the time of the claim.

The above limitations and exclusion will apply whether or not the customer's claim is in contract, tort (including negligence and gross negligence), breach of warranty or condition,

misrepresentation (whether negligent for otherwise) or otherwise at law or in equity, even if we has been advised of the possibility of such damages or such damages are reasonably foreseeable. Nothing in this manual shall exclude, or in any way limit, our liability for death or personal injury solely and directly caused by their negligence, or that of its employees, agents, or sub-contractors (as applicable), fraud, or fraudulent misrepresentation, or any other liability to the extent the same is proven in a court of competent jurisdiction in a final non-appeal- able judgment and may not be excluded or limited as a matter of local law.



THE INVERTER THAT LOOKS AT THE FUTURE

zcsazzurro.com



Zucchetti Centro Sistemi S.p.A.
Green Innovation Division
Palazzo dell'Innovazione - Via Lungarno, 167
52028 Terranuova Bracciolini - Arezzo, Italy
zcscompany.com

