



USER'S MANUAL



EV CHARGER

1PH 7KW



ZUCCHETTI
Centro Sistemi



EV CHARGER 1PH 7kW User Manual



General instructions

This manual contains important safety instructions that must be followed during installation and maintenance of the equipment.

Please keep these instructions!

This manual must be considered an integral part of the equipment, and must be available at all times to everyone who interacts with the equipment. The manual must always accompany the equipment, even when it is transferred to another user or plant.

Copyright statement

Copyright of this manual belongs to Zucchetti Centro Sistemi S.p.A. No part of this manual may be copied (including the software), reproduced or distributed in any form or by any means without the permission of Zucchetti Centro Sistemi S.p.A. All rights reserved. ZCS reserves the right to final interpretation. This manual is subject to change based on feedback from users, installers or customers. Please check our website at <http://www.zcsazzurro.com> for the latest version.

Technical support

ZCS offers a support and technical consultancy service accessible by sending a request directly from the website www.zcsazzurro.com

The following toll-free number is available for the Italian territory: 800 72 74 64.

Table of Contents

1. Preliminary safety instructions	8
1.1. Safety instructions	8
1.2. Symbols and icons	12
1.3. Labels	13
2. Product features	13
2.1. Product presentation.....	14
2.2. Operating diagram.....	15
3. Installation	17
3.1. Checks before installation	17
3.1.1. Installation tools	19
3.2. Installation process.....	21
3.2.1. Installation position	21
3.2.2. Movement of the charger	21
3.3. Materials and cables.....	21
4. Electrical connections	23
4.1. Connecting PGND cables (grounding)	23
4.2. Connecting the AC power cables.....	25
4.3. External protection devices.....	27
4.4. Communication systems	27
5. Mounting.....	29
5.1. Wall mounting	29
5.2. Mounting on metal support	30
5.3. Locking.....	31
6. Commissioning.....	32
6.1. Preliminary safety inspection	32
6.2. Starting the charging station	32
7. Configuration	33



7.1.	Procedure	33
7.2.	Password setting, mode of use and power limitation	34
7.3.	Menu for repairs or maintenance	36
7.4.	Configuration of RFID card (to enable charging in online and offline mode)	37
8.	Working mode	39
8.1.	Online	39
8.2.	Offline	40
8.3.	Plug&Play.....	41
9.	ZSM-GATEWAY.....	42
9.1.	Introduction.....	42
9.2.	Product overview	42
9.3.	Features.....	43
9.3.1.	OCCP 1.6 Protocol.....	43
9.3.2.	Management of charger unit	43
9.3.3.	LED indications	45
9.4.	Installation	45
9.4.1.	Installation tips	45
9.4.2.	Installation materials	45
9.4.3.	ZSM-GATEWAY positioning	46
9.5.	Commissioning	46
9.6.	Ethernet connection	47
9.7.	Wi-Fi Configuration.....	47
9.8.	Back-end configuration	51
9.9.	EVChargo monitoring portal.....	54
9.10.	ZSM-GATEWAY update.....	54
10.	Operation	55
10.1.	Connecting the charger to the electric vehicle	55
10.2.	Start of charging	55
10.3.	End of charging	55
11.	Technical datasheet	56

12.	Troubleshooting and maintenance	57
12.1.	Troubleshooting	57
12.2.	Maintenance.....	60
13.	Dismantling and disposal	61
14.	Warranty	62

Preface

General information

Please read this manual carefully before installation, use or maintenance. This manual contains important safety instructions that must be followed during installation and maintenance of the system.

Scope

This manual describes the assembly, installation, electrical connection, commissioning, maintenance and troubleshooting of the EV CHARGER:

1PH 7kW



Keep this manual so that it is accessible at all times.



Recipients

This manual is intended for qualified technical personnel (installers, technicians, electricians, technical support personnel or anyone who is qualified and certified to work on an electrical system), responsible for installing, starting up and operating the charging station.

Symbols used

This manual provides information for safe operation and uses certain symbols to ensure the safety of personnel and materials, and for efficient use of the equipment during normal operation. It is important to understand this information to avoid accidents and damage to property. Please take note of the following symbols used in this manual.

	<p>Danger: indicates a hazardous situation which, if not resolved or avoided, could result in serious personal injury or death</p>
	<p>Warning: indicates a hazardous situation which, if not resolved or avoided, could result in serious personal injury or death</p>

	<p>Caution: indicates a hazardous situation which, if not resolved or avoided, could result in minor or moderate personal injury</p>
<p>Caution</p>	
	<p>Attention: indicates a potentially hazardous situation which, if not resolved or avoided, could result in damage to the system or other property</p>
<p>Attention</p>	
	<p>Note: provides important tips on the correct and optimal operation of the product</p>
<p>Note</p>	

1. Preliminary safety instructions



Note

If you have problems or questions in reading and understanding the following information, please contact Zucchetti Centro Sistemi S.p.A. through the appropriate channels.

1.1. Safety instructions

Highlights the safety instructions to be followed during installation and use of the equipment.

Before installing and using the equipment, make sure you read and understand the instructions in this manual and familiarise yourself with the relative safety symbols shown in this chapter. According to national and local requirements, permission must be obtained from your local provider before connecting to the electrical grid, making sure that the connections are carried out by a qualified electrician. All installation work must be carried out by a qualified and competent electrician.

Contact the nearest authorised service centre for any repairs or maintenance. Contact your distributor for information on the nearest authorised service centre. **DO NOT** carry out repairs yourself, as this may result in injury or damage.

Qualified personnel

Ensure that the operator has the necessary skills and training to operate the equipment. Personnel responsible for use and maintenance of the equipment must be qualified and capable of performing the activities described, and must also have appropriate knowledge on how to correctly interpret the contents of this manual. For safety reasons, this charging station can only be installed and serviced by a qualified electrician with the necessary training and/or skills and knowledge. Zucchetti Centro Sistemi S.p.A. declines all responsibility for damage to property or personal injury caused by incorrect use of the device.

Do not attempt in any way to repair or replace components of the charging station without the assistance of qualified personnel.

Installation requirements

Install and start the charging station according to the following instructions. Place the charging station on suitable load-bearing supports with sufficient load capacity (such as metal walls or columns) and make sure it is positioned vertically. Choose a suitable location for the installation of the electrical equipment. Make sure there is sufficient space for heat dispersion and to accommodate future maintenance. Maintain adequate ventilation and ensure that there is enough air circulation for cooling.

The charging station display must not be exposed directly to sunlight.



Danger

Do not place the charging station near explosive, flammable materials, chemical vapours or potentially hazardous materials.







Figure 1 - Do not lose or damage this manual

Transport requirements

If you encounter problems with the packaging that could damage the charging station or if you find any visible damage, immediately notify the transport company. If necessary, request assistance from an installer or from Zucchetti Centro Sistemi S.p.A. Transport of the equipment, especially by road, must be carried out with vehicles suitable to protect the components (in particular, electronic components) against violent knocks, humidity, vibrations, etc.

Electrical connections



Please follow all the electrical regulations on accident prevention.

	Before connecting the electrical cables, make sure to properly disconnect the voltage on the AC connection cables, and do not connect any charging cables for electric vehicles.
Danger	
	All installation operations must be carried out by a professional electrician, who has carefully read this manual and understands its contents!
Warning	
	Before connecting the charging station to the grid, make sure that all the necessary permits have been obtained from the local grid operator and that all the electrical connections have been completed by a professional electrician.
Attention	
	Do not remove the information label or tamper with the charging station. Otherwise, ZCS will not provide any warranty or assistance
Note	

Operation



Do not use the product if it has any defects, cracks, scratches or leaks, but contact your dealer or ZCS technical service.

	Contact with the electrical grid or the terminal of the equipment may cause electrocution or fire!
Danger	<ul style="list-style-type: none"> • Do not touch the terminal or the conductor connected to the electrical grid. • Follow all the instructions and safety requirements relating to grid connection

	<p>If the charging station is not functioning properly:</p> <ul style="list-style-type: none"> • Disconnect the input and output power supply
Warning	
	<p>Take special care when charging in thunderstorms or in rain</p>
Attention	

Maintenance and repair

Keep the charging station clean and dry; if you need to clean it, use a clean dry cloth. It is very dangerous to touch the inside of the charging station, therefore it is strictly forbidden to do so while the system is running. NEVER clean the inside of the charging station with a wet or damp cloth.

	<ul style="list-style-type: none"> • Before performing any repairs, disconnect the charging station from the power supply (AC side) and from the data connection to the transmission gate. • After switching off the DC switch, wait 5 minutes before carrying out any repairs or maintenance on the charging station
Danger	
	<ul style="list-style-type: none"> • The charging station should start working again after any faults have been fixed. For repairs, contact your local authorised service centre • Do not disassemble the internal components of the charging station without permission; this will void the warranty.
Attention	

1.2. Symbols and icons

Introduces the main safety symbols on the charging station. Some safety symbols are located on the charging station. Read and understand the contents of the symbols before installation:









	<p>Be careful of high voltage</p>
	<p>Complies with the European Standards</p>
	<p>Ground connection point</p>
	<p>Read this manual before installing the charging station.</p>
	<p>Degree of protection of the equipment according to the IEC 70- 1 standard (EN 60529 June 1997). IP54 means that it is resistant against water and rust, therefore also suitable for outdoor operation and maintenance.</p>

Table 1 – Symbols present on the charger

1.3. Labels

AC7000 - BE - 24	
EV AC Charger	
Nominal Voltage: 220-240V ac	
Nominal Current: 32A	
Nominal Frequency: 50Hz	
Nominal Power: 7kW	
Protection Grade: IP54	
	
	
SN10C05193220001 Made in China	

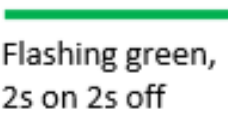
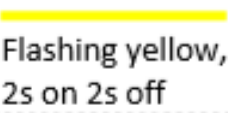
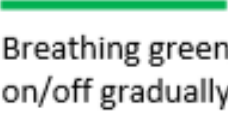
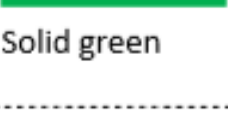
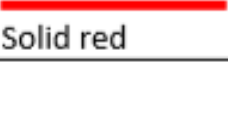
	STANDBY Power-on, but no gun plug-in
	READY TO CHARGE Gun plug-in, but not start charging yet
	IN CHARGING Gun plug-in, and start charging by RFID\APP
	STOP CHARGING Charging stop, but gun is still plug-in
	FAULT Error happens



DO NOT remove the labels. **DO NOT** cover with sheets, supports, cabinets, etc. Always keep them clean and legible.

Figure 2 - Labels present on the charging station

2. Product features

2.1. Product presentation

The EV CHARGER 1PH 7kW series are electric vehicle battery chargers that can communicate with the Battery Management System (BMS) of vehicles and provide them with the power needed for charging, thus guaranteeing the protection of the electrical system. They do not convert the mains voltage or current but simply regulate the flow and have internal protection devices in case of short circuit or other types of battery faults. The charging station draws the energy needed from the photovoltaic system (if present) or from the grid, depending on availability. The figure below shows a typical installation (the photovoltaic system inside the barred box).

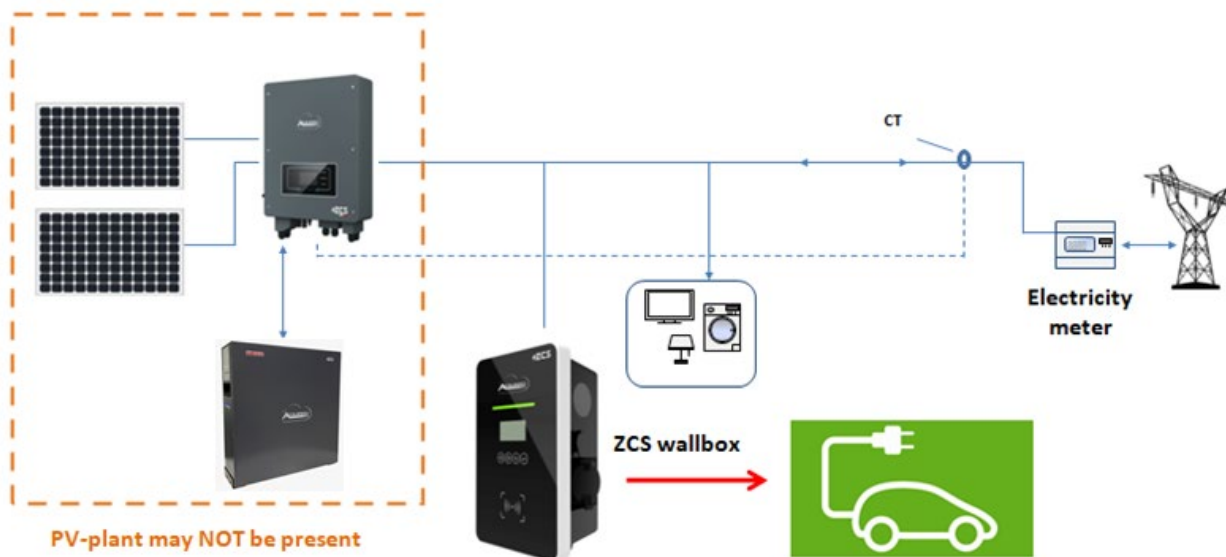

Figure 3 - Example of a charging station connected to a PV system (optional) and grid

The charging stations can only be connected to grids with voltage and frequency values within the range specified in the technical datasheet. It is also very important to know the installation requirements in order to understand exactly which configurations to adopt and which options to choose.

Accessories and optional components of the charging station should be chosen by a qualified technician who is familiar with the installation conditions.

Overall dimensions: L × D × H = 356mm × 221mm × 136mm

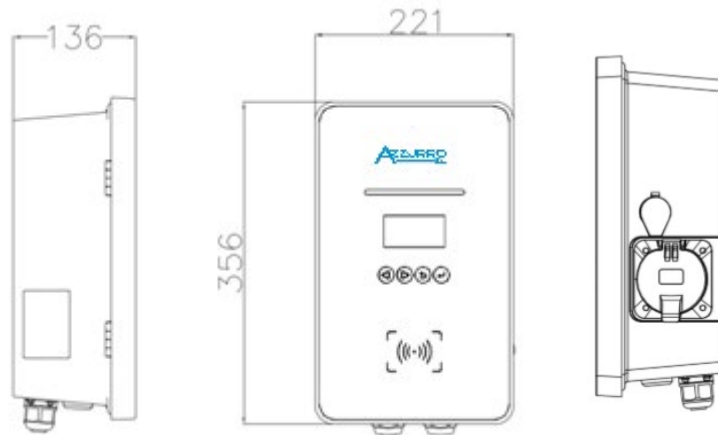

Figure 4 – Front and side view of the charging station

2.2. Operating diagram

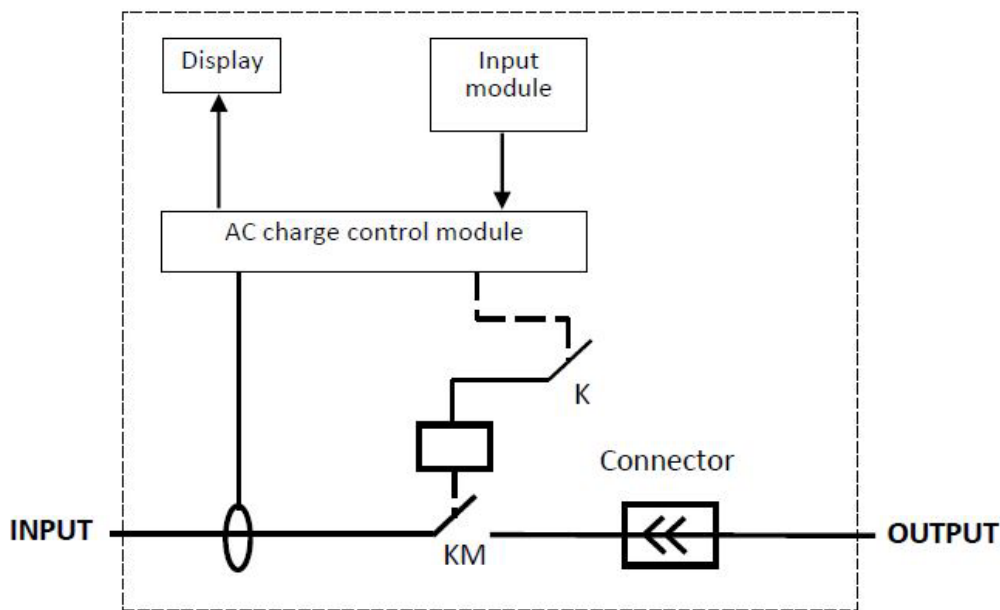

Figure 5 – Operating diagram of the charging station

The charging station connects to an electric vehicle via a Type2 connector (the cable is optional). According to the standards, the charging station is identified with Type3 (wall-box) in which the station is responsible for any power limitations, protections of various types and start-stop charging. No energy conversion takes place inside the charging station.

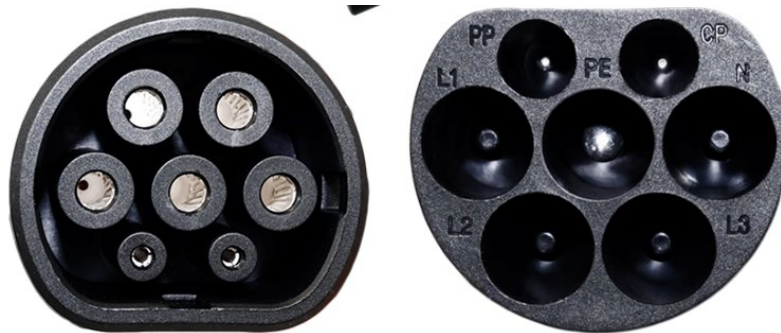

Figure 6 - Type2 connector

The station is equipped with a MID metering system that measures the energy supplied to the vehicle. The possible connection with an external communication gate also allows remote control of the station, billing of the energy and other functions. It is compatible with all types of cables and power sockets in order to ensure safe charging.

It is designed according to the EN 61851-1:2011 and EN 61851-22:2002 international standards, which makes it compatible with industry standards. It can be connected to internet via WiFi/Ethernet/4G and then monitored via PC or app.

3. Installation

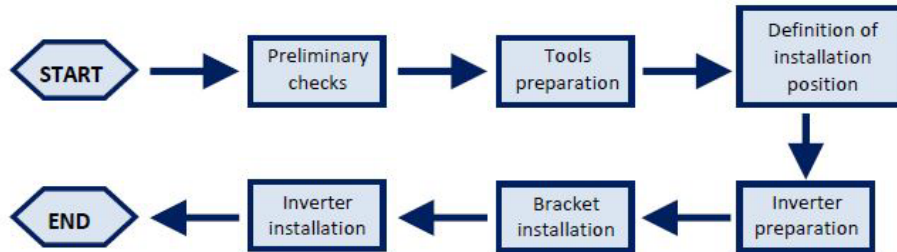



Figure 7 - Installation procedure

	<ul style="list-style-type: none"> • DO NOT install the charging station near flammable materials. • DO NOT install the charging station in an area where flammable or explosive materials are stored.
Danger	
	<ul style="list-style-type: none"> • Take into account the weight of the charging station during transport and installation. • Choose an appropriate mounting position and surface.
Attention	

3.1. Checks before installation

Checking the outer packaging





Packaging materials and components may be damaged during transport. Therefore, it is recommended to check the materials of the outer packaging before installing the charging station. Check the surface of the box for external damage such as holes or tears. If any type of damage is detected, do not open the box containing the charging station and contact the supplier and the courier as soon as possible.

It is also recommended that you check the contents of the packaging and make sure that they correspond to what was declared. If not, contact your dealer to have any missing parts sent to you.

Checking the product

After removing the charging station from its packaging, check that the product is intact and complete. If any damage is found or components are missing, contact the supplier and transport company.

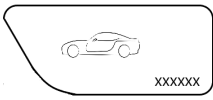
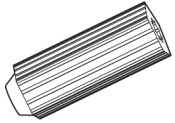
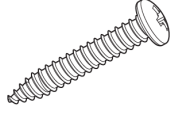
Contents of the packaging

No.	Part	Qty
1	 Charging station	1
2	 Screw with built-in washer	4
3	 Front opening keys	2
4	 RFID activation card	2
5	 Expansion plug	4
6	 Self-tapping screw	4
7	 Quality inspection sheet	1





8		Jig for wall holes	1
9		Warranty	1

Table 2 - Package contents

3.1.1. Installation tools

The following tools are required for the installation of the charging station and electrical connections; therefore, they must be prepared before installation.

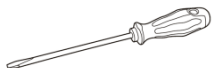
No.	Tool	Function
1		Screwdriver To screw and unscrew screws for the various connections
2		Drill To drill holes in the wall for fixing
3		Diagonal pliers To cut and tighten the cable ends
4		Crimping tool To crimp the power cables
5		Wire stripping tool To remove the outer sheath of the cables

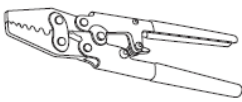
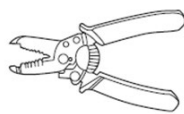



6		Rubber hammer	To insert the expansion plugs into the wall holes
7		Multi-meter	To check the voltage and current values
8		Marker pen	To mark the wall for better fixing precision
9		Measuring tape	To measure distances
10		Level	To make sure the bracket is level
11		ESD gloves	Protective clothing
12		Safety goggles	Protective clothing

Table 3 - Installation tools

3.2. Installation process

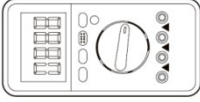
3.2.1. Installation position

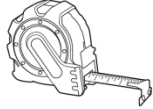
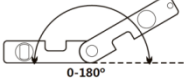
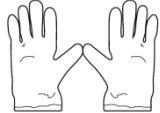
Choose an appropriate installation location for the charging station. Follow the requirements below to determine the installation position.

The installation location chosen should allow easy access to the charging station for normal operation and maintenance.

For safety reasons, ZCS and/or its authorised partners may not perform repairs/maintenance or move the chargers from and to the ground if they are installed at a height of more than 180 cm. Stations installed at higher heights must be moved to the ground before they can be repaired or serviced.

3.2.2. Movement of the charger

- 1) Open the packaging and remove the polystyrene protection cover, insert your hands into the slots and take hold of the device;
- 2) Lift the charging station from its packing box and move it to the installation position, then remove the polystyrene protections.

	<ul style="list-style-type: none"> • To prevent damage and personal injury, hold the device securely when moving as it is a heavy piece of equipment • Always position the device horizontally
Attention	

3.3. Materials and cables

First name	Specifications	Quantity
Power cord	$\geq 3 \times 6\text{mm}^2$ single-phase	Second requirement
Mains cable	STP, CAT5E, 8 cores	Second requirement
Connector for mains cable	RJ45	Second requirement

Insulating tape	0.15 mm × 18mm; 0-600V; 0°C-80°C	Second requirement
Cable tie	4 × 200mm	Second requirement

Table 4 - Electrical equipment

It is important that all cables used are suitable for outdoor use

NOTE: For safety reasons, make sure to use suitably sized cables, otherwise the current may cause overheating or overloading, which could result in a fire.

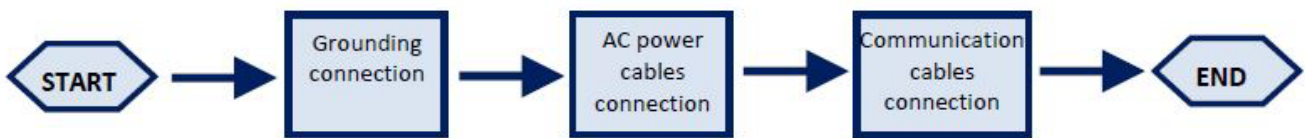





Figure 8 - Logical sequence for cable connection

4. Electrical connections

This chapter describes the electrical connections of the 7kW charging station. Carefully read this section before connecting the cables. All the local, regional and national regulations must be complied with during installation, repair and maintenance of the product.

 Attention	<p>Before making any electrical connections, make sure there is no AC current. Zucchetti Centro Sistemi Spa assumes no responsibility for any liabilities arising from the use of this product. Installation must be carried out by a qualified professional with the skills and knowledge to build, install and operate electrical systems, and who has been trained on how to identify and prevent potential risks.</p>
 Attention	<p>The charging station must be installed and serviced by professional technicians or electricians.</p>
 Attention	<p>The charging station must be installed and serviced by professional technicians or electricians.</p>

4.1. Connecting PGND cables (grounding)

Connect the charging station to the ground electrode using the ground protection cables (PGND).

Prerequisites:

Prepare the PGND cables to be connected (it is recommended to use outdoor power cables with a cross-section of 6 mm² suitable for grounding).

Procedure:

- 1) Remove a suitable length of the external insulation layer using a wire stripper, as shown in Relative figure.

Note: L2 is approximately 2- 3 mm longer than L1

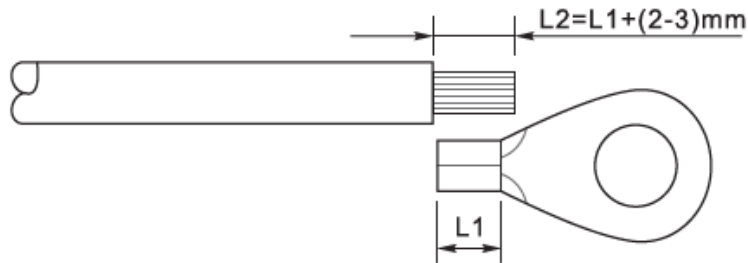

Figure 9 – Preparing the ground cable (1)

1) Insert the exposed wires into the OT terminal and crimp them using a crimping tool, as shown in relative Figure.

Note 1: L3 is the length between the insulation layer of the ground cable and the crimped part. L4 is the distance between the crimped part and the conductor wires protruding from the crimped part.

Note 2: The cavity formed after the conductor has been crimped must completely wrap the conductor wires. The core of the wire must be in close contact with the terminal.

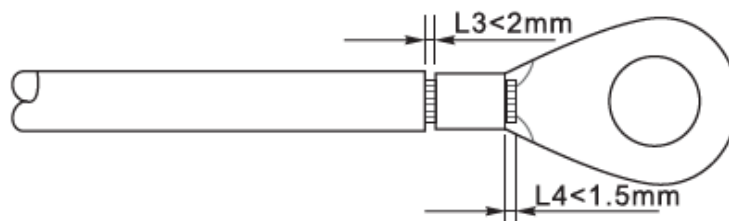

Figure 10 – Preparing the ground cable (2)

2) Install the crimped OT terminal and flat washer by inserting the M5 screw into the hole located on the lower bar of the charging station, as shown in the figure; tighten the screw to a torque of 3 Nm using a screwdriver.

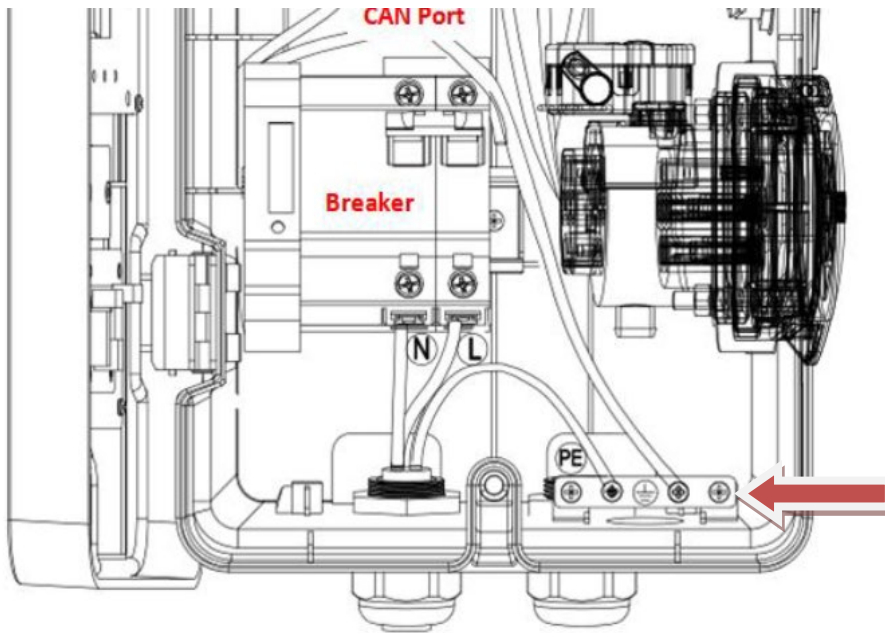

Figure 11 - Connecting the ground terminal

4.2. Connecting the AC power cables

Connect the station to the AC power supply network or power grid using AC power cables.

Context

The AC power cables used for the charging station must be three-pole outdoor cables. For easier installation, use flexible cables. The specific section recommended for connections is at least 6mm².



Note

For safety reasons, make sure to use suitably sized cables, otherwise the current may cause overheating or overloading, which could result in a fire.

Cable connection procedure

- 1) Remove a suitable length of the protective sleeve, as shown in the figure (A: 80~100 mm B: 6~8 mm).

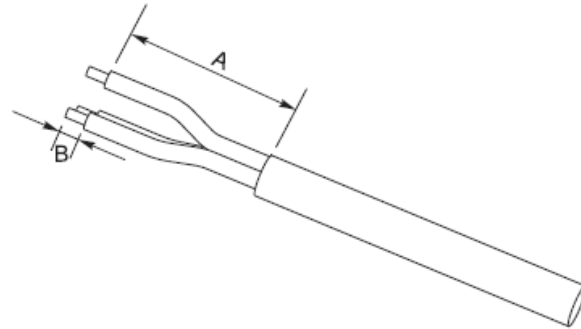

Figure 12 - Connecting the AC output cables (1)

2) Connect the AC power cable according to the following criteria:

- Connect the ground wire (yellow-green) to the hole labelled “PE”, and tighten the cable using a screwdriver as described in the previous paragraph.
- Connect the line wire (brown) to the hole labelled “L”, and tighten the wire using a screwdriver.
- Connect the neutral wire (blue) to the hole labelled “N”, tighten the wire using a screwdriver.

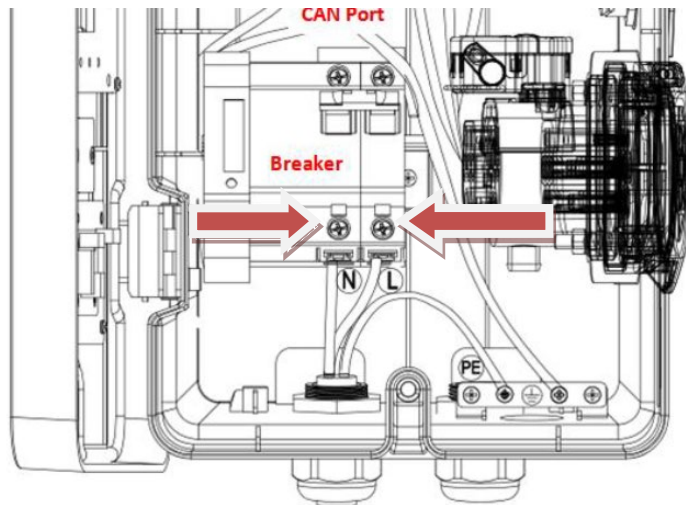

Figure 13 - Connecting the AC output cables (2)



Attention

Do not reverse the “line” and “neutral” connections. The device will signal an error with the status bar flashing red.

4.3. External protection devices

The charging station is equipped with a Residual Current Device (RCD) to detect any current faults. It is also equipped with a detection system for DC components above 6mA. It is recommended to install a magnetothermal device with a suitable capacity on the AC connection cables for installation, uninstallation, maintenance and disconnections caused by other reasons.

4.4. Communication systems

The charging stations are equipped with CAN bus communication systems. The charging station can be monitored and controlled by connecting it to external communication gates (e.g. ENGATE or ZCS Connex).

The cable connection does not depend on the type of mounting (wall or floor). The power cables pass through the inlet at the bottom of the charger and connect to the corresponding PE, L and N inputs on the switch terminals inside the charger. A network cable is required to connect the charger to the communication gate which has internet access via Ethernet/WiFi/4G. One end of the network cable connects to the charger's CAN port on the PCBA. The other end of the network cable connects to the CAN port of the communication gate through the CAN port at the base of the charger. Details on EN-GATE or ZCS Connex can be found in the specific manual.

For more information and instructions on how to connect the cables, contact ZCS technical service. The connection is possible using the CAN ports shown in the figure. There are two connectors as it is possible to connect up to 12 charging stations to the same external device.

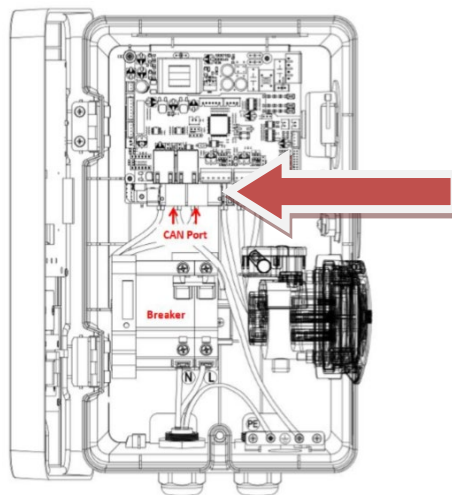

Figure 14 - Communication system

When grouping chargers together, for example, in public car parks, a single gate functions as an access gate for up to 12 chargers. The gate is connected to charger #1 and the other chargers are connected one by one via network cables between the various CAN ports (relative Figure). The length of the network cable between the gate and charger #1 should be $\leq 10\text{m}$, while the total length of the network cables between the gate and the farthest charger should be $\leq 100\text{m}$.

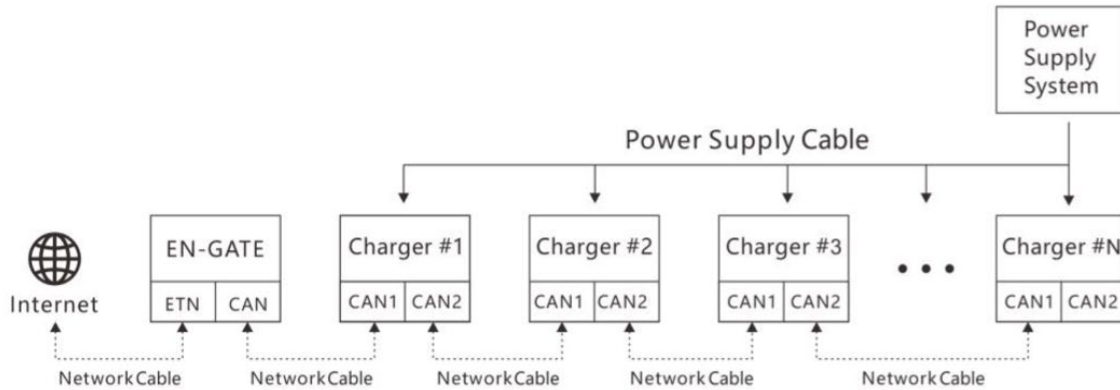

Figure 15 - Connecting the charging stations

5. Mounting

5.1. Wall mounting

- 1) Identify the installation position and mark the two holes for the wall screws, which will be inserted in the top rear of the charging station. You can use the hole jig found in the package.
- 2) Drill two holes with the 6mm diameter drill bit and insert the plugs horizontally into the holes, paying attention to the force and depth with which they are inserted (make sure the plug completely enters the hole).
- 3) Insert the two M4x32 screws into the wall plugs, allowing the heads of the screws to protrude by at least 5 mm.
- 4) Provisionally position the charging station by inserting the head of the screws into the upper holes at the rear.
- 5) Open the front of the charging station using the wrench provided.
- 6) Mark the position of the third fastening screw. The hole is located at the bottom of the charging station.
- 7) Remove the station and make the third hole, inserting the wall plug.
- 8) Reposition the station and secure the third screw at the bottom.

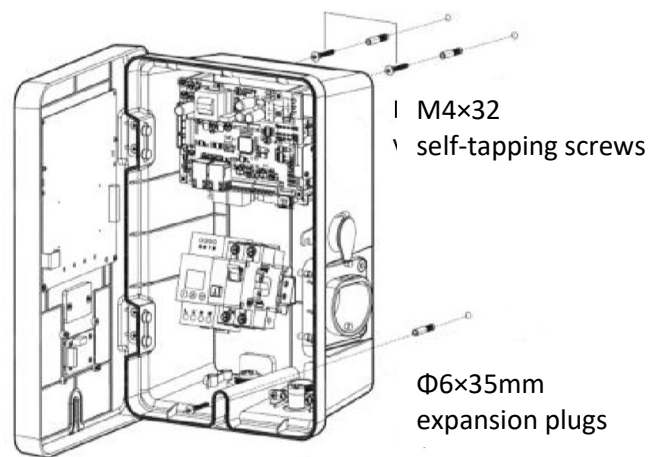

Figure 16 - Positioning of screws for wall mounting

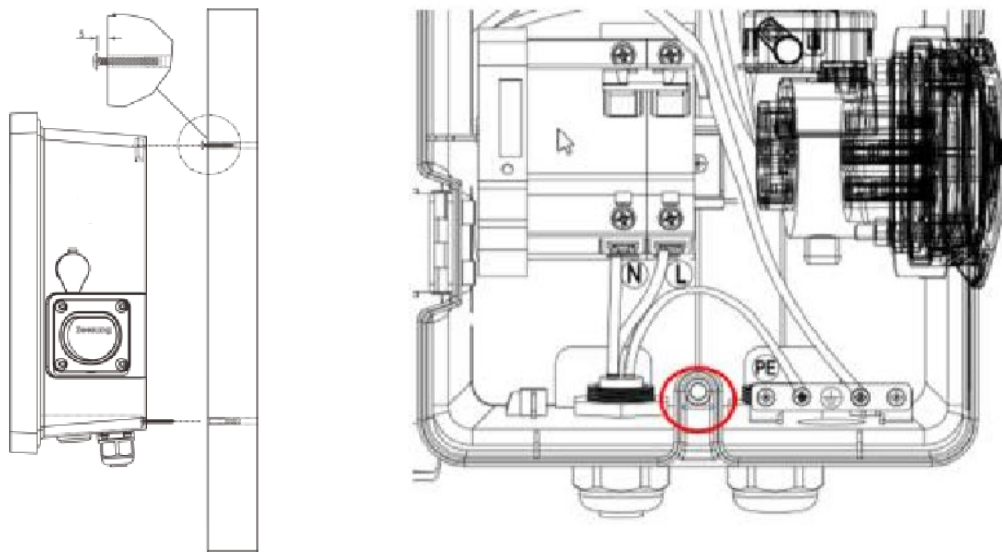

Figure 17 - Wall fixing

5.2. Mounting on metal support

- 1) After positioning the metal support and routing the connection cables, place the station on top of the support.
- 2) Fix the station from below using the screws contained in the mounting kit.

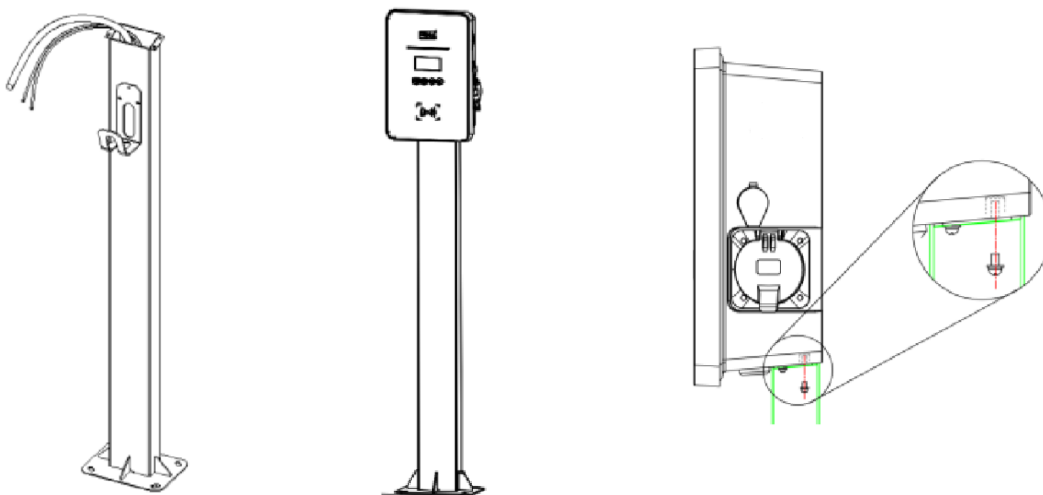

Figure 18 - Positioning of support post

5.3. Locking

The locking of the charger housing does not depend on the type of mounting. Turn on the switch inside and close the front cover of the charger with the wrench supplied. The locks are located on the right side.

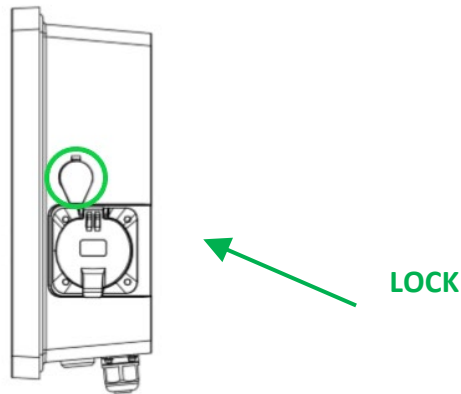
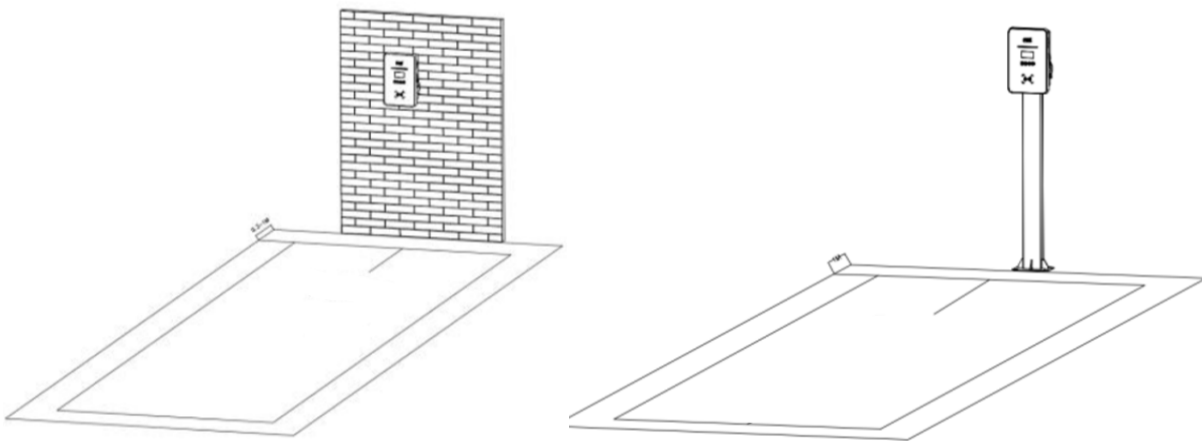

Figure 19 - Side view of charger

	<p>Pressing lightly on the front cover will make it easier to close and open the charger.</p>
<p>Note</p>	

Figure 20 - Final positioning of charging station



	<p>The charging station display must not be exposed directly to sunlight.</p>
<p>Attention</p>	

6. Commissioning

6.1. Preliminary safety inspection

	<p>Make sure that the AC voltage falls within the range permitted by the device.</p>
<p>Attention</p>	

Check the following points before starting up the charging station:

- 1) Positioning: Check that the position is stable and solid and that the charging station does not move unintentionally.
- 2) Front closure: make sure that the front of the device is properly closed by the side locks. Also check that the emergency button is not pressed; if necessary, turn it slightly to release it.
- 3) Protection: set appropriate values for the protection switch of the AC input current leakage.
- 4) Other components: make sure no components or other objects remain on top of the charger.

6.2. Starting the charging station

After checking all the points in the previous section, proceed with the actual start-up of the charging station. The charger must be switched on and the indicating lights (LEDs) on the display should be in standby mode.

Status	Description	LED lights
Standby	ON, but charger not plugged in	Green light flashing , 2s on and 2s off
Ready to charge	Battery charger plugged in, but hasn't started charging	Yellow light flashing , 2s on and 2s off
Charging	Battery charger plugged in, and has started charging	Green light flashing slowly , gradually on/off
Charging interrupted	Charging interrupted, but battery charger still plugged in	Green light steady
Error	Various types of errors	Red light steady

Table 5 - Operating states

7. Configuration

 Note	<p>Configuration is necessary for the commissioning of the electric vehicle charging station; without it the charger may not work or may work incorrectly</p>
--	--

7.1. Procedure

- 1) After installing the charging station properly (see sections 2, 3, 4, and 5), power it up and check that the display doesn't show any faults or errors, and that the LED line is not flashing green. The keypad consists of 4 keys, indicated here below.



Back



Next



Cancel/Back



Confirm/Enter

Figure 21 - Control keypad

- 2) Press the Confirm/Enter key for at least 10 seconds
- 3) The screen shown in relative Figure appears; use the Next, Back and Confirm/Enter keys to write the password. Password: 123456

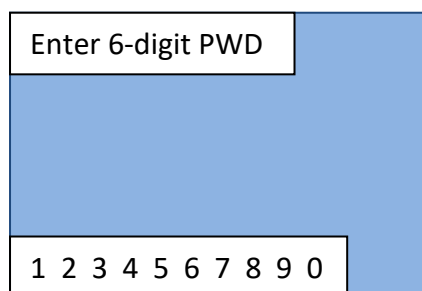

Figure 22 - Password selection screen

- 4) If the password is entered correctly, the page shown in relative Figure opens, which contains all the device configurations. The menu items can be selected using the Next and Back keys.

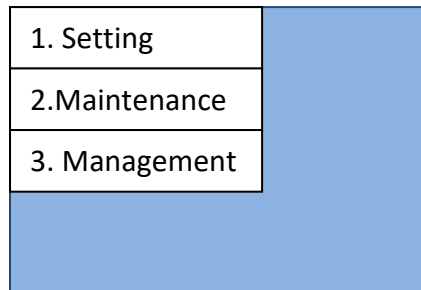

Figure 23 - Main configuration screen

7.2. Password setting, mode of use and power limitation

- 1) From the screen shown in relative Figure, select point '1. Settings' and press the Confirm/Enter key. Wait for the page shown in relative Figure to appear.

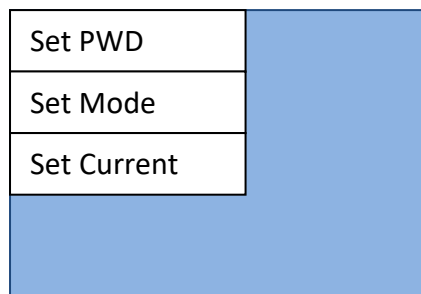

Figure 24 - Password, mode of use and power configuration screen

- 2) To change the password (NOT RECOMMENDED!) select 'Set PWD' to set the new password, as shown in the screen below.

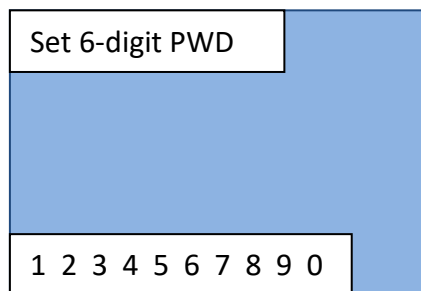



Figure 25 - Password setting screen

	<p>Once the password has been changed, you will no longer be able to reset it. Losing the new password means losing access to the device for future configuration changes. Therefore, it is highly recommended not to change the password.</p>
Attention	

- 3) To set the mode of use, select 'Set Mode' from the screen in shown in relative Figure. Two screens (Figure a and Figure b) will open in sequence within seconds of each other. Do not press any keys while waiting for the screen shown in relative Figure to appear.

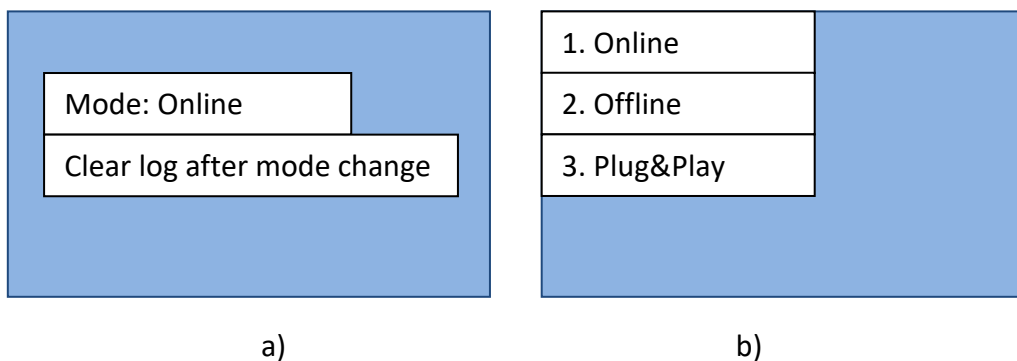

Figure 26 - Screen for setting working mode

- 4) Select the desired working mode. Please note that the charging station can be used in the following ways:
- **Online** – requires an ENGATE connection;
 - **Offline** – launches the charge only with authorised cards;
 - **Plug&Play** – simply connect the car to start charging automatically.

Wait for the device to restart automatically.

- 5) To set the maximum power (i.e. current) limit for the device, select 'Set Current' from the screen in relative Figure. Two screens (Figure a and Figure b) will open in sequence within seconds of each other. Do not press any keys while waiting for the screen shown in relative Figure to appear.

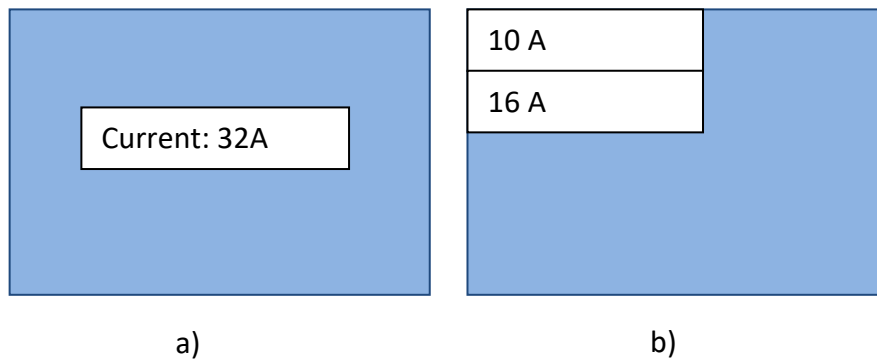

Figure 27 - Screen for setting the current limit

- 6) Select the desired current limit. The following power limits can be set:
- 32A corresponds to the maximum limit of 7kW for single-phase and 22kW for three-phase;
 - 25A corresponds to the maximum limit of 5.8kW for single-phase and 17.3kW for three-phase;
 - 16A corresponds to the limit of 3.5kW for single-phase and 11kW for three-phase;
 - 10A corresponds to the limit of 2.3 kW for single-phase and 6.6kW for three-phase.
- Wait for the device to restart automatically.

7.3. Menu for repairs or maintenance

- 1) From the screen shown in relative Figure, select item '2. Maintenance' and press Confirm/Enter. Wait for the screen shown in relative Figure to appear.

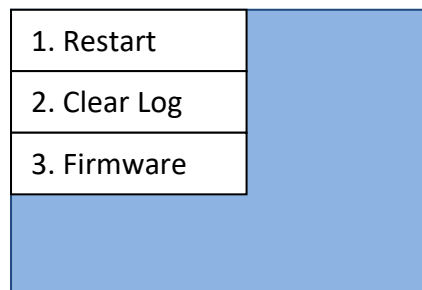

Figure 28 - Maintenance screen

- 2) Select '1. Restart' to restart the device manually. Confirm in the screen shown in relative Figure.

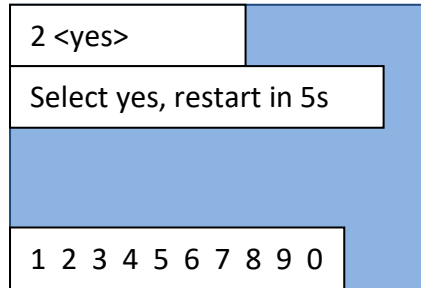

Figure 29 - Restart screen

- 3) Select 'Clear log' from the screen shown in relative Figure to clear the list of events on the device. Confirm in the screen shown below.

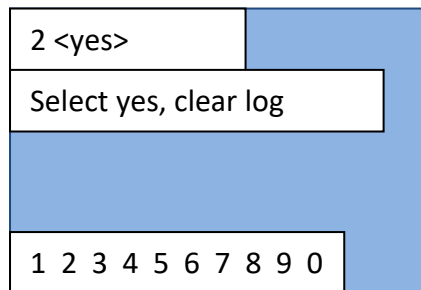

Figure 30 - Clear Log screen

- 4) Select '3. Firmware' from the screen shown in relative Figure to view the software version of the device.

7.4. Configuration of RFID card (to enable charging in online and offline mode)

- 1) From the screen shown in relative Figure, select item '3. Management' and press Confirm/Enter. Wait for the screen shown in relative Figure to appear.

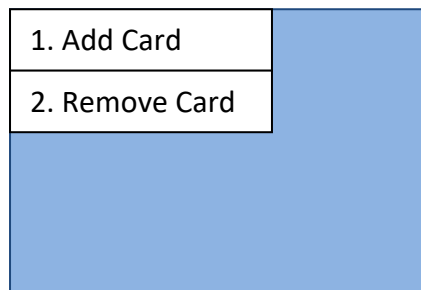

Figure 31 - RFID card control screen

- 2) To add a card for activating the charging, select '1. Add Card' and wait for the screen shown in relative Figure to appear.

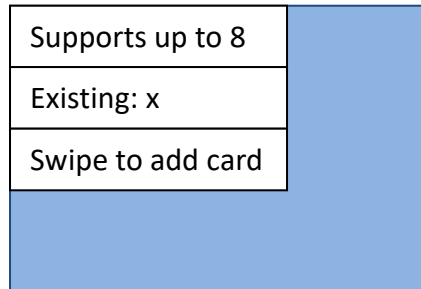

Figure 32 - Add Card screen

Swipe the card to be added on the device reader; the reader is recognisable by the symbol shown in relative Figure present on the front of the device.



Figure 33 - RFID Card Reader Symbol

- 3) To remove a charging card, select '2. Remove card' from the screen shown in relative Figure and wait for the screen shown in relative Figure to appear.

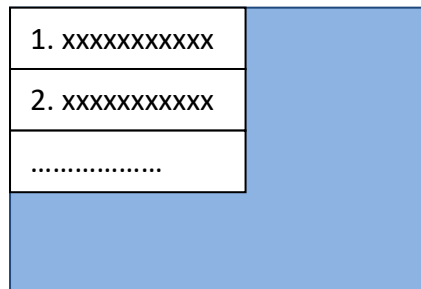

Figure 34 - Card removal screen

- 4) Select the card to be removed with the Next and Back keys and confirm removal with the Confirm/Enter key.

8. Working mode

Refer to chapter 6 for configuring the various modes.

8.1. Online

This operating mode is typical for large users with multiple battery chargers on the same network who need to manage charging authorisations, charging bookings, remote stops and starts, billing system, etc.

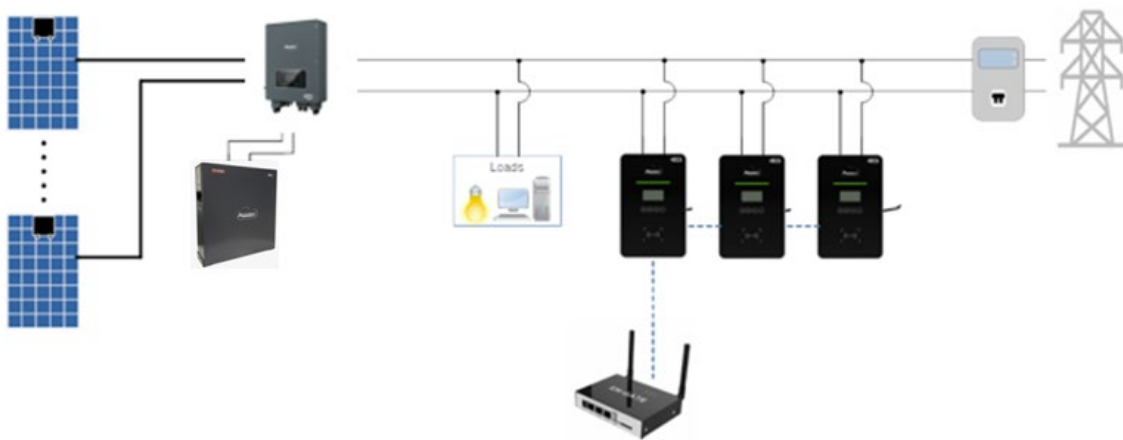

Figure 35 - Online mode

The charger is set to online mode by default, so this is how it will be set the first time it is turned on. The online charging mode can only be set if the ENGATE is connected for managing authorisations, invoices, and other configurations, the RFID cards are optional.

If the customer wants to check the authorisations and invoices by using the ONLINE configuration by connecting to the ENGATE in order to use the portal that has already been developed. Up to 10 chargers can be connected to the same ENGATE via the CAN port; the ENGATE is powered through the CAN port, if the connection distance to the first battery charger is less than 10 meters, otherwise, an additional power supply is required (external 12V power supply unit, see the chapter on ENGATE for details).

This is typically used in the city, or in large shopping centres, with the aim of providing this service to customers through a complete billing system; for this purpose, it is necessary to inquire about the legal aspects of this service. The charging can be started or stopped by scanning the RFID card or QR Code accessed via the appropriate app installed on the customer's smartphone. After configuring and connecting the ENGATE, check the indications on the display of each connected charger to verify the presence of the icons:



Icon	Description
	No connection to the portal - Plug & Play working mode and with Connex
	ENGATE connected correctly and not connected to the portal - check ENGATE configuration
	ENGATE connected correctly and connected to the portal

Table 6 - icon for connection to ENGATE

8.2. Offline

This working mode allows the charger to operate without any connection to the portal; the charging is authorised through RFID cards, which can be configured locally via the display. Each pack includes two RFID cards which can be configured to activate the charging.

No billing system is implemented in this configuration. The ZCS Connex connection can be used, which only allows the charger to be monitored via the Azzurro portal.



Figure 36 - Offline mode

For example, it can be used in a hotel or holiday farmhouse as a service offered to guests. Using RFID cards prevents generic charging of vehicles, but only allows holders of an enabling key to charge their vehicles.

8.3. Plug&Play

This working mode allows the charger to work simply by connecting the charger gun to the car, there is no need for authorizations, cards, payments or anything else; there is no need for other devices.

Whenever the customer does not need to request authorizations, charge limits, blocks, monitoring needs or specific configurations, the simplest configuration is in Plug & Play mode; recharging is initiated by the car's BMS simply through the physical connection of the magazine gun to the car and stopped through disconnection. In this working mode there is no possibility of invoicing. There is the possibility of using the connext ZCS connection and this will only allow monitoring via the Azzurro portal.

Typical use is for private homes, i.e. end users with an electric car in their garage, possibly with their own photovoltaic system.

Applications of this kind concern the use of Connex on the ZCS app which allows you to optimize the amount of energy to be stored, used, etc.

Please refer to the information about ZCS Connex for these details.



Figure 37 - Plug&Play mode

9. ZSM-GATEWAY

9.1. Introduction

EN-GATE is a control module for the online management of wallboxes. This user manual is a guide for the installation, commissioning and operation of the ZSM-GATEWAY system, and provides useful information on its technical installation and use.

Before any operation, please read this document carefully to understand how the device works. Keep this manual handy at all times.

9.2. Product overview

The ZSM-GATEWAY device is an energy gateway that controls the communication between the chargers and backend. The chargers can be connected in a daisy chain and managed by a single gateway; this then has the function of managing the entire unit, allowing a maximum of 12 chargers to be connected.

The aim is to minimise communication costs, limiting the number of data transmission devices to one; in this way, less pressure is placed on the cloud server where the backend is located.

TECHNICAL DATA	ZVM-GATEWAY
Dimensions	125.3 x 91.5 x 28.3(HxWxD)
Installation method	Mounted on wall near the wallbox
Power supply	CAN / external power connection
Working voltage	12-25V
Working current	500mA
Protection class	IP21
Working temperature	between -20°C and +50°C
Platform/system	Linux ARM9 system
LED indicators (left to right)	Operating status, connection to backend, connection to charger
MTBF (Mean Time Between Failures)	100,000 Hours
Protections	Anti-inversion connection
Maintenance inputs	Micro USB, UART
Data input	USB
EN-GATE v.s. Charger communication	CAN
EN-GATE v.s. backend communication	Ethernet
Internet communication protocol	OCPP1.6
Extension port	IO, TTL USART
Maximum number of chargers connected to EN-GATE	10 pieces

9.3. Features

9.3.1. OCCP 1.6 Protocol

The ZSM-GATEWAY system is connected to the chargers via a CAN communication input and via Ethernet port for communication with the Internet.

Using the OCCP 1.6 communication protocol, the ZSM-GATEWAY reports the information of the charger to the backend in real time, as well as information of control operations such as reservations, and charging start and stop. As the OCCP 1.6 position is open, the ZSM-GATEWAY can also easily be coupled with other backends that support OCCP1.6 communication protocols.

For more information please contact ZCS Azzurro support.

9.3.2. Management of charger unit

In charger units in a car park (for example), a single ZSM-GATEWAY can act as a communication gateway for a maximum of 12 chargers. Each charger has 2 CAN inputs:

- one for the physical connection between the ZSM-GATEWAY and charger no. 1;
- the other for daisy chaining between the chargers, as shown in relative Figure.

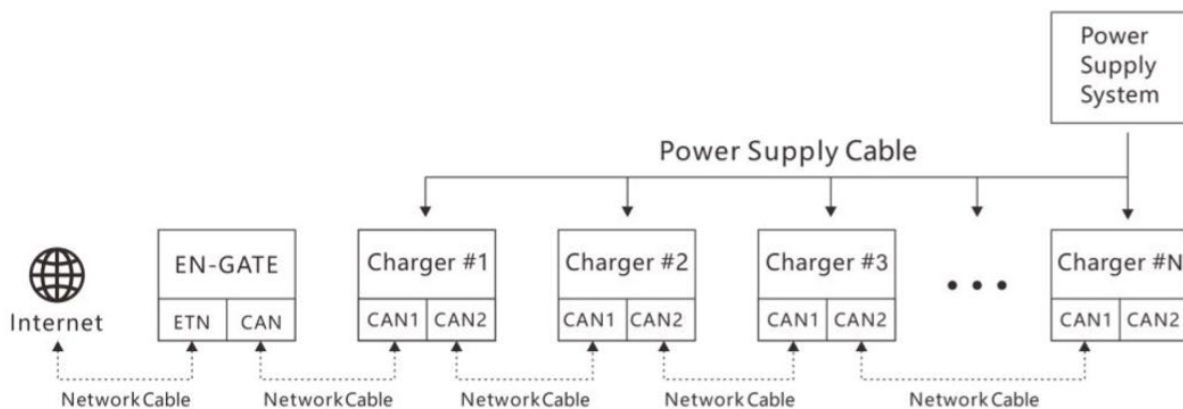

Figure 38 - Connection between ZSM-GATEWAY and the chargers

The length of the communication cable between the ZSM-GATEWAY and charger no. 1 should be less than 10 meters, and the maximum distance between the ZSM-GATEWAY and the last charger in the chain should be less than 100 meters.

The balancing of the loads prevents overloading of one charger at the expense of the others; the ZSM-GATEWAY actively manages and distributes the available power among all the chargers. In applications with multiple chargers, the ZSM-GATEWAY has shown to be a Smart energy management system, especially in a system where limited power is available.

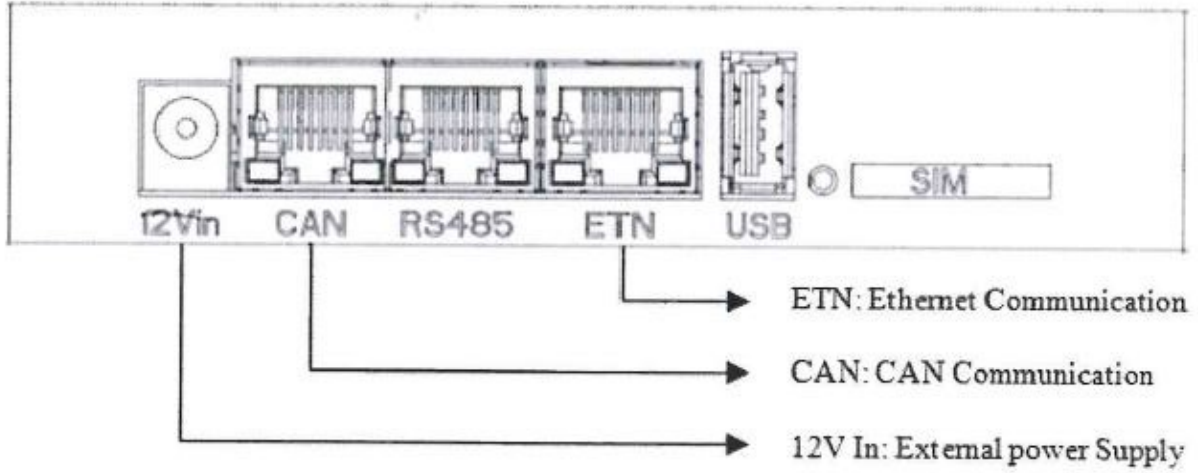

Figure 39 - Definition of inputs

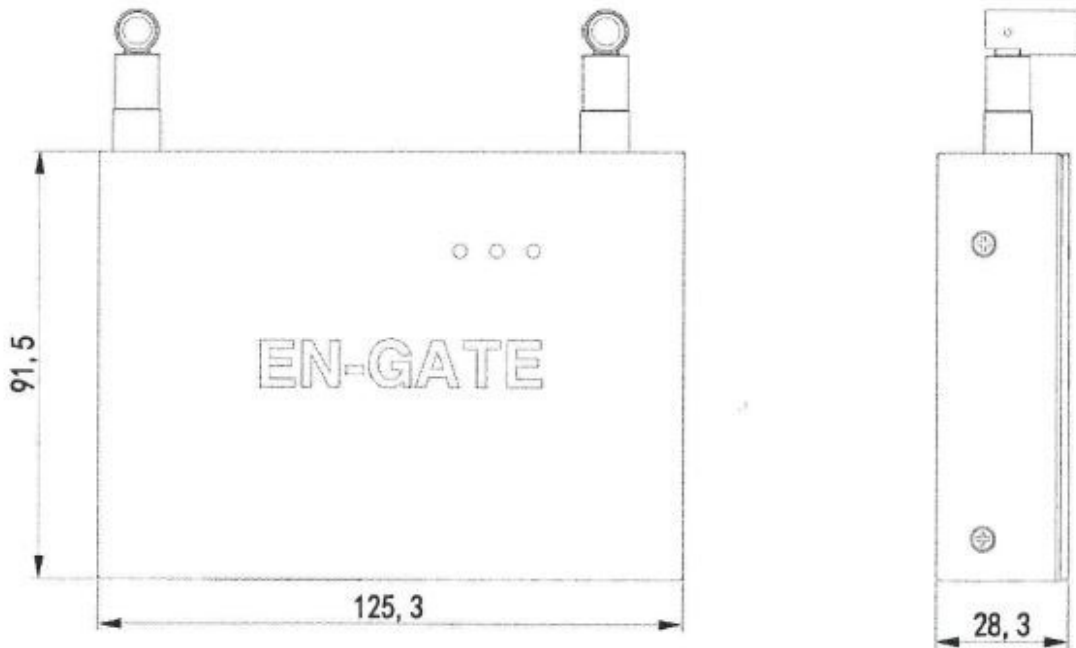

Figure 40 - Device dimensions

9.3.3. LED indications

Reference LED	Definition
Operating status (left)	Green light flashing: ZSM-GATEWAY in operation Green light steady/off: ZSM-GATEWAY not in operation
Back-end connection (centre)	Green light steady: ZSM-GATEWAY and Back-end connected Flashes once: back-end is communicating Off: connection between ZSM-GATEWAY and back-end failed
Connection to charger (right)	Green light steady: Connection established Flashes once: charger is communicating Off: connection between ZSM-GATEWAY and back-end failed

9.4. Installation

9.4.1. Installation tips

The CAN connection between the ZSM-GATEWAY and devices can also function as a power supply, and not only for sending data. The distance between the ZSM-GATEWAY and the chargers should be less than 10 meters, otherwise another 12-24V power supply unit is required as an additional external power supply.

The standard installation is mounting to an indoor wall. If the system needs to be installed outdoors, additional weather protection is required, as the device has a protection class of IP21.

9.4.2. Installation materials

Number	Specifications	Quantity
Network cable	Shielded network cable, Cat. 5	As required
Network cable connector	RJ45	As required
Cable ties	4 x 200 mm	As required

9.4.3. ZSM-GATEWAY positioning

In accordance with the project, route the power and communication cables to the location of the ZSM-GATEWAY.

Follow the instructions in this manual regarding the connection of multiple chargers to the same ZSM-GATEWAY. The standard installation is mounting to an indoor wall; the reference dimensions for

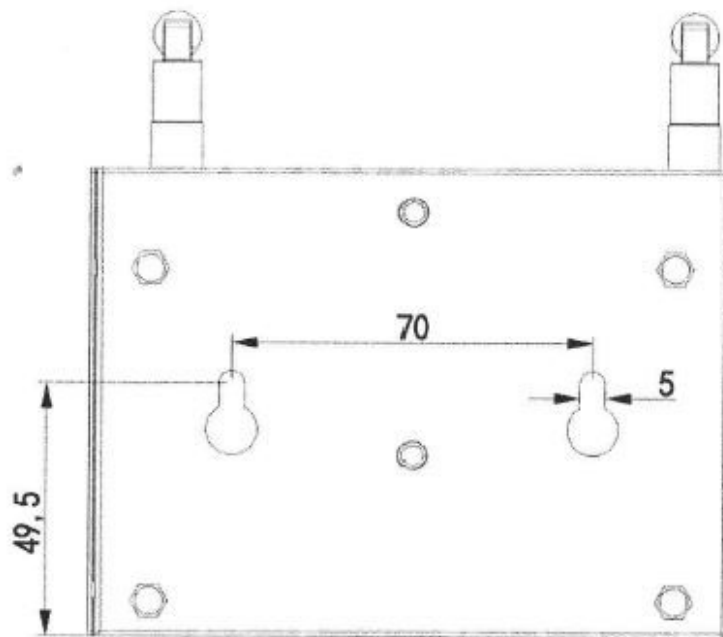

positioning the supports are shown in relative Figure.

Figure 351 - Dimensions for installation

If the ZSM-GATEWAY is installed outdoors, extra protection is required to protect it from the weather.

9.5. Commissioning

Before commissioning the device, check that the cables are connected properly.

1. Switch on the chargers and check the status of the LEDs, and those on the ZSM-GATEWAY. If they are not on, use a multimeter to check whether there is a problem with the cables or power supply.
2. The LED indicating lights on the chargers should be flashing green. If the chargers are not working properly, check the manual and, if necessary, contact the dealer. The “ADD” symbol should appear in the top right-hand corner of the charger display.

- The status of the LEDs on the ZSM-GATEWAY should be as follows (left to right): flashing green light, steady green light, steady green light.
If the LEDs do not correspond, check the connections and if necessary contact the dealer.

9.6. Ethernet connection

To connect the system to the internet, the Ethernet cable must be connected to the ETN port on the device; the network cable connected to Charger no. 1 must be connected to the CAN port.
Once the connections have been made, make sure the connection is active and running.
If the LED of the internal connection is not on, check that the network cables are connected to the correct ports and that the cables are crimped.

9.7. Wi-Fi Configuration

In order to communicate correctly, the ZSM-GATEWAY device must be connected to a local Wi-Fi network so that it is able to send data.

The device must be powered and switched on.

- Use a mobile phone to search for the Wi-Fi hotspot of the ZSM-GATEWAY. Search for a network that looks like: ENGATE_XXXXXX (where the last 6 digits correspond to the serial number of the device).
- The password of the Wi-Fi network is 12345678
- Check the “automatic reconnect” box.

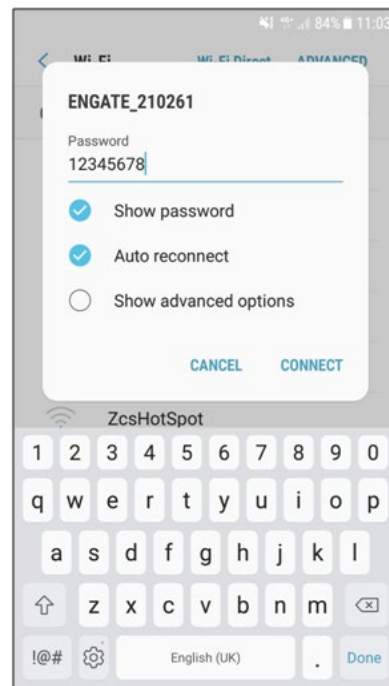
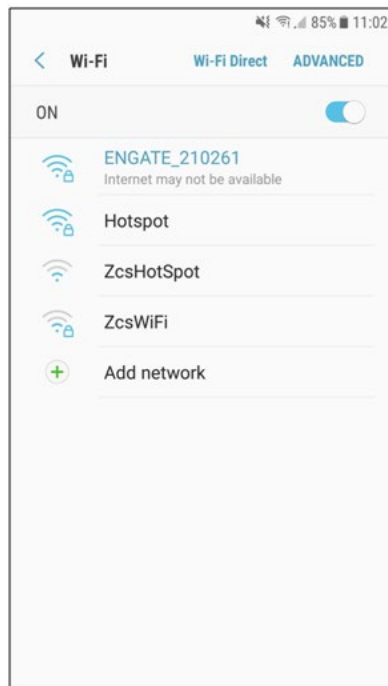

4. When connection with the network has been established, open Google Chrome and type 192.168.5.1 in the address bar; the communication web interface will open for configuring the device.
5. Log in to the page using the credentials:
Username: **admin**
Password: **admin**

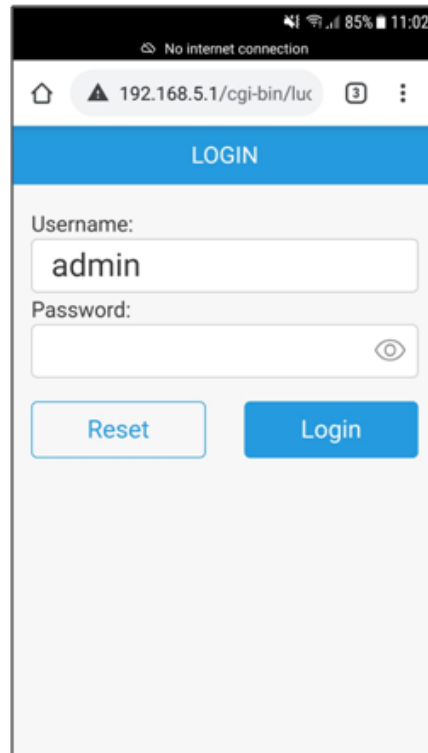

- Click on “Search Wi-Fi”, select the available Wi-Fi network and enter the network password. Click “Confirm.” To connect to the device, you need to have a stable signal and know the password of the Wi-Fi network.

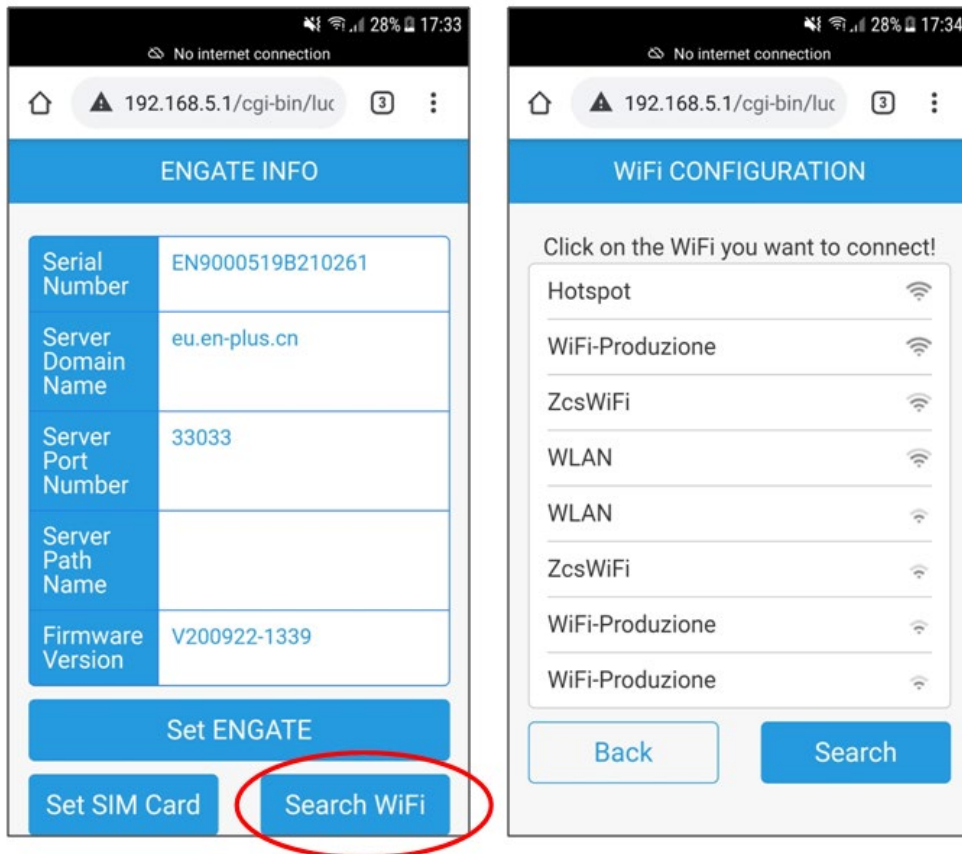

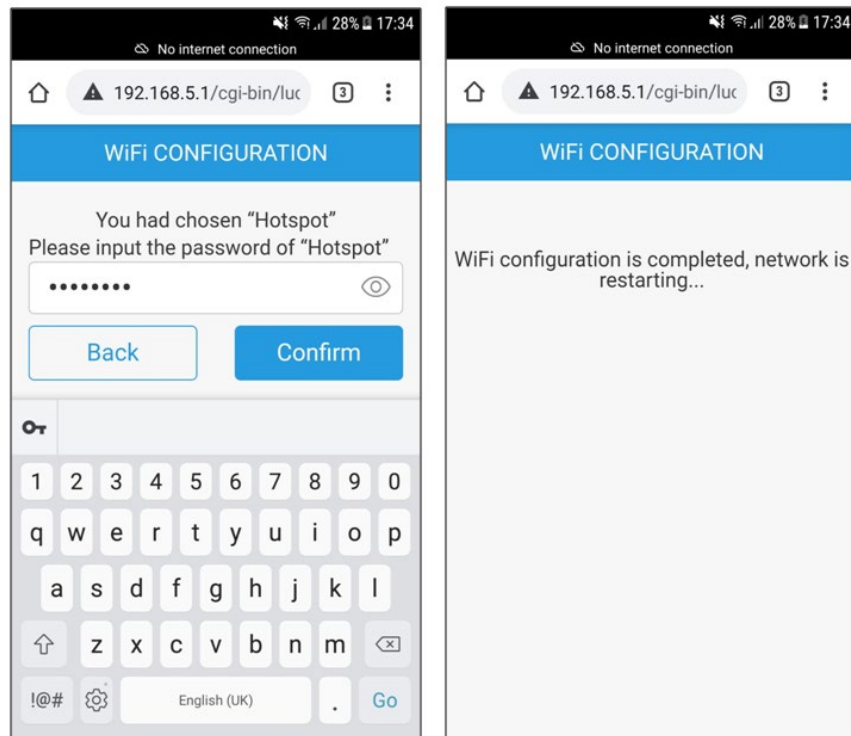

7. If the connection is successful, the gateway will restart automatically.
8. Wait until the 3 LEDs on the device are all lit up (steady or flashing LEDs), which means that the configuration is successful and the device is ready to communicate.

9.8. Back-end configuration

The ZSM-GATEWAY communicates by default with the manufacturer's back-end. If communication with another back-end is necessary, the settings need to be changed. For further information, contact the dealer.

1. From the same initial status page, click "Set ENGATE."

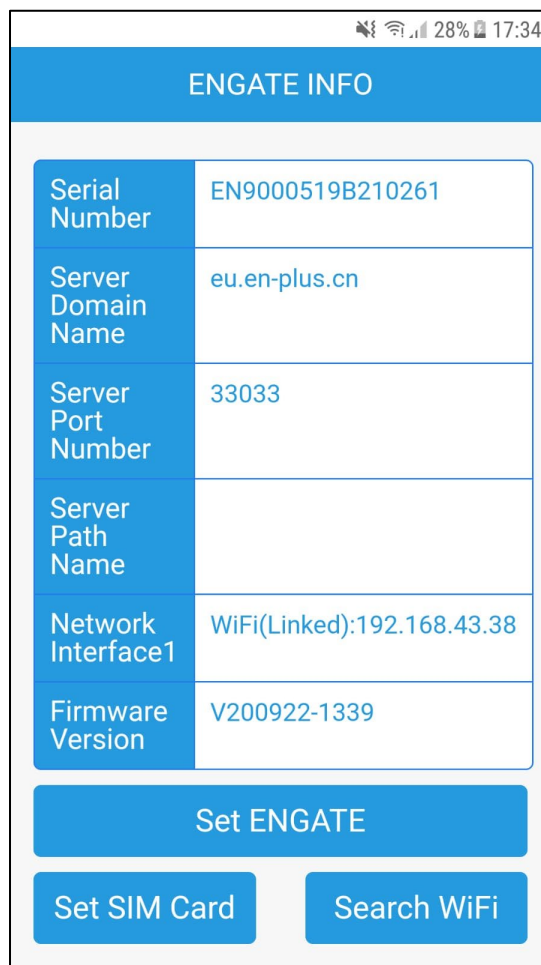

ENGATE INFO	
Serial Number	EN9000519B210261
Server Domain Name	eu.en-plus.cn
Server Port Number	33033
Server Path Name	
Network Interface1	WiFi(Linked):192.168.43.38
Firmware Version	V200922-1339

Set ENGATE

Set SIM Card Search WiFi

- When the screen opens, the manufacturer's credentials are present by default. They must be deleted:

Server IP: eu.en-plus.com
Server Port: 33033

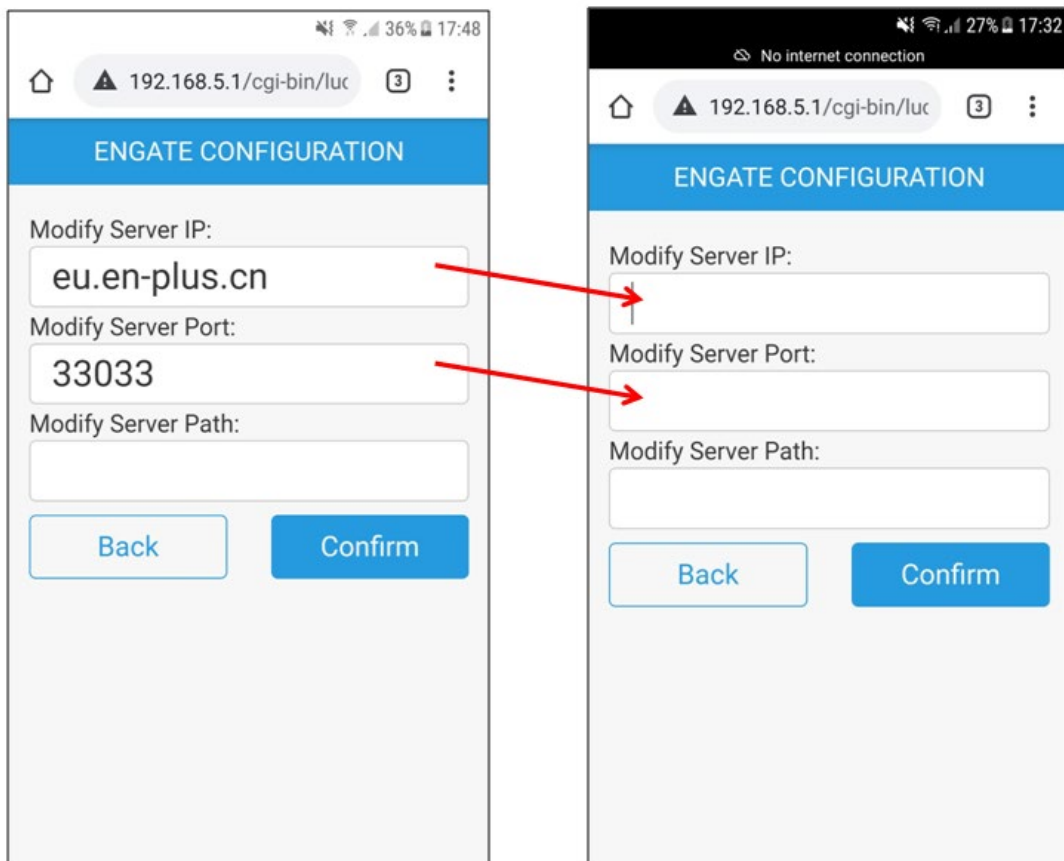

- Enter the credentials of Azzurro ZCS as follows:

Server IP: ocpp16.evcharge.com
Server Port: 33033

Click "Confirm."

- If the settings are correct, the gateway will restart.

5. Check that the Wi-Fi and Back-end settings have been saved in the “ENGATE INFO” screen.

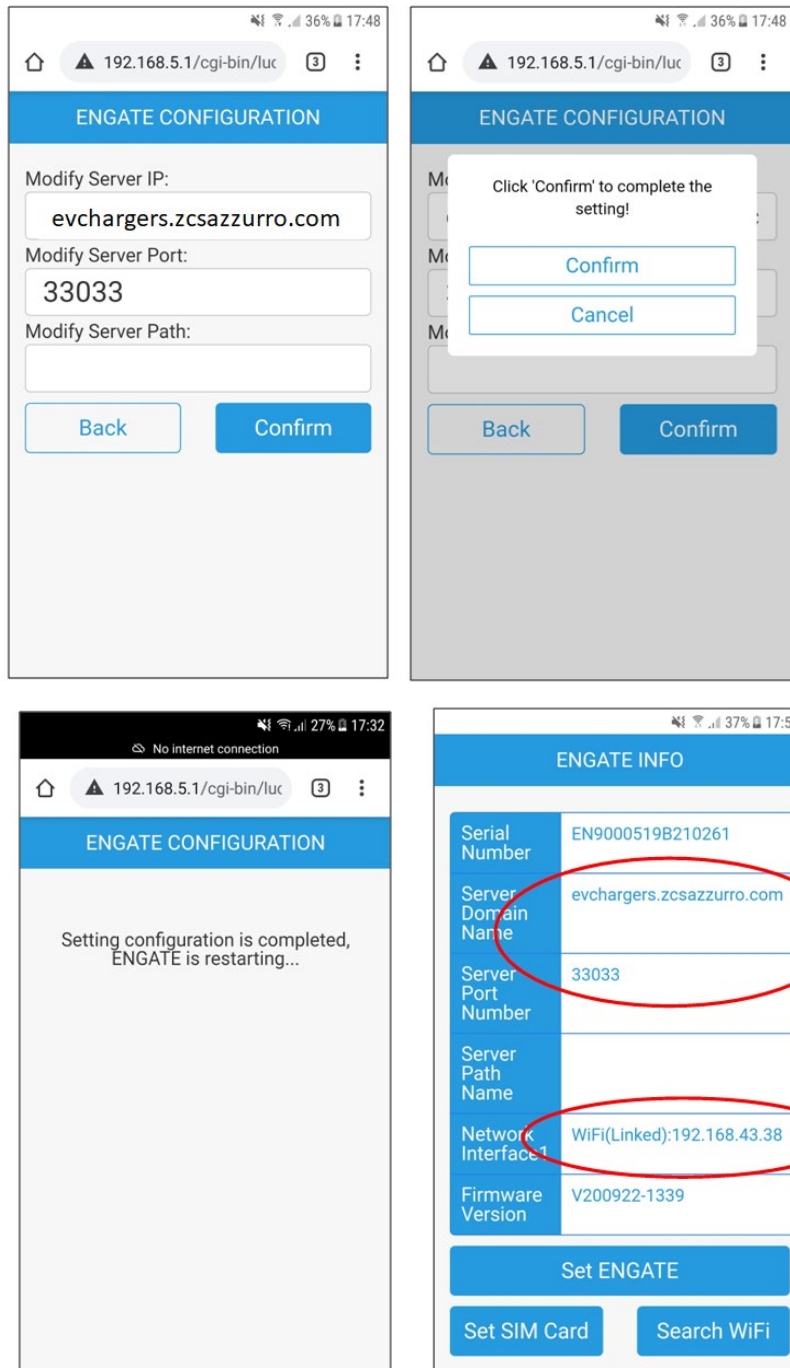

To configure a back-end other than Azzurro, such as public charging networks like EvWay, NextCharge, etc, complete the fields:

- Server IP
- Server Port
- Server Path

according to the instructions, and wait for the device to restart.

9.9. EVChargo monitoring portal

For the use of the monitoring portal, please refer to the dedicated documentation on the website <http://www.zcsazzurro.com/>.

In the section on charging stations see the document "User Manual Evchargo Portal"

In addition, for the creation of the account on the new portal: <https://cloud.evchargo.com/> please email us the following data so that we can activate them and properly configure the new account:

- company name or how to call the account
- email with which to register

Send us this data by opening a ticket from our website <http://www.zcsazzurro.com> in the section Support/Request assistance and commercial info.

Once you have created your account, you will receive a notification email from notification@evchargo.com with your account password.

9.10. ZSM-GATEWAY update

If the device needs to be updated after consulting with technical support, request the necessary files and save them on a USB memory stick.

1. The USB stick must ONLY contain one folder named "OCPP_UPLOADER."
2. Power up the gateway and wait until the LEDs light up
3. Insert the USB stick
4. The LED on the left side of the gateway will start to flash quickly for about 20 seconds.
5. When it starts flashing slowly again, the update is complete.
6. Switch off the gateway and remove the USB stick.

10. Operation

10.1. Connecting the charger to the electric vehicle

Position the electric vehicle near the charger, making sure the cable is not taut.

- 1) Pull out the battery-charger cable from the electric vehicle and connect the charger and electric vehicle connectors.
- 2) Check that the connectors are positioned correctly and secured properly. When properly connected, the LED on the charger should flash yellow, indicating that the charger is ready to charge the vehicle.

10.2. Start of charging

After the connector has been connected to the electric vehicle and is ready to charge, scan the RFID card (depending on the mode selected) once on the identification area of the front panel in order to start the charging operation.

When charging starts, the connector will be secured to the socket, until otherwise instructed; the charger will display real-time information on the charging status, such as electricity supplied, charging time, voltage, current and power.

10.3. End of charging

When the electric vehicle is fully charged, the charging will stop and the charging LED will turn solid green. To interrupt the charging, depending on the mode selected, scan the RFID card for a second time. If the card is not scanned, the charger will not recognise the end of the charging process and will not allow the connector to be disconnected from the charging socket (electric vehicle). Another way to stop the charging is to end the session from the side of the electric vehicle. After the connector has been disconnected from the vehicle side, the charging session is interrupted and the connector can be automatically disconnected from the charger side as well.

11. Technical datasheet

TECHNICAL DATA	1PH 7KW	3PH 22KW
AC Input data		
Type of connection	Single-phase (1PH + Neutral + PE)	Three-phase (3PH + Neutral + PE)
AC input voltage	230V +/- 10%	400V +/- 10%
AC input frequency	50Hz	50Hz
AC Output data		
AC output voltage	230V +/- 10%	400V +/- 10%
Maximum AC output current	32A	32A
Maximum Power	7.4 kW (limitable from display)	22 kW (limitable from display)
General data		
Outer casing material	Plastic PC940	Galvanised steel
Front panel	Tempered glass	Tempered glass
Installation	To wall / On support metal	To wall / On support metal
Connector	Type2 Connector with shutter - cables not included (optional)	Type2 Connector with shutter - cables not included (optional)
LCD screen	Graphic screen	Graphic screen
Controls	4 touch keys - contact for RFID	4 touch keys - contact for RFID
RFID card	2 included	2 included
Energy Meter	MID Certificate	MID Certificate
RCD protection	TypeA + 6mA DC	TypeA + 6mA DC
Protection class	IP54	IP54
Cooling	Natural convection	Natural convection
Environmental Data		
Operating temperature	-30°C / +50°C	-30°C / +50°C
Humidity	5% / 95% non-condensing	5% / 95% non-condensing
Maximum operating altitude	2000m	2000mt
Installation	Indoor / Outdoor	Indoor / Outdoor
Safety protections		
Integrated protections	Over and under voltage, power overload, short circuit, dispersion currents, missing ground connection, surge, over and under temperature	Over and under voltage, power overload, short circuit, dispersion currents, missing ground connection, surge, over and under temperature
Applicable safety standards	IEC 61851-1: 2017, IEC 62916-2: 2016	IEC 61851-1: 2017, IEC 62916-2: 2016
Warranty	2 years	2 years
Dimensions and parts accessories		
Dimensions (H + L + D)	356mm + 221mm + 136mm	452mm + 295mm + 148mm
Weight	3 kg	10 kg
Accessories	Communication gateway (Ethernet/ WIFI/4G), Ground mounting support, Type2-Type2 cable (4m)	Communication gateway (Ethernet/ WIFI/4G), Ground mounting support, Type2-Type2 cable (4m)

12. Troubleshooting and maintenance

12.1. Troubleshooting

This section contains information and procedures on how to troubleshoot any faults and errors that may occur during operation of the charging station.

If you have any problems please follow these steps:

- 1) Check the warning messages and error codes on the information panel of the device. Record them before carrying out any further operation.
- 2) If the charging station does not display any errors, perform the following checks:
 - Is the device located in a clean, dry and properly ventilated place?
 - Are the cables correctly sized and as short as possible?
 - Are the connections in good condition?
 - Are the configuration settings correct for the type of installation?

Information on the event list:

Problems	Possible causes	Solutions
OverVolt	In most cases, the issue is caused by the unstable grid. So please wait for some time to check if it can recover itself.	<ol style="list-style-type: none"> 1. Power off the charger and then power it on to check if the issue is gone 2. If the issue is always there, please use a multimeter to check if the voltage is normal, about 230V if the measurement is not normal, it is related to the grid. 3. if the measurement is not normal, it is related to the grid. 4. if the measurement is normal, but the charger still report the error, there is something wrong with the PCBA of the charger.
UnderVolt	In most cases, the issue is caused by the unstable grid. So please wait for some time to check if it can recover itself.	<ol style="list-style-type: none"> 1. Power off the charger and then power it on to check if the issue is gone 2. If the issue is always there, please use a multimeter to check if the voltage is normal, about 230V if the measurement is not normal, it is related to the grid. 3. if the measurement is not normal, it is related to the grid.

		<ol style="list-style-type: none"> 4. if the measurement is normal, but the charger still report the error, there is something wrong with the PCBA of the charger.
OverCurrent	In most cases, the issue is related to the EV. So please try to charge a different EV and check if the issue is gone.	<ol style="list-style-type: none"> 1. If the issue is gone when charging a different EV, it means the charger has no any issue. 2. If the issue still exists when charging any EV, it means there is something with the PCBA of the charger.
OverFreq	Normally, the issue is caused by unstable grid.	<ol style="list-style-type: none"> 1. wait the grid to be stable. 2. reboot the charger to check if the error is gone
Over DCLC		<ol style="list-style-type: none"> 1. Power off the charger and power it on. 2. If the issue is still there, try to charge a different EV. 3. if the issue is gone when charge another EV, the issue is related to the EV. 4. If the issue is randomly there, try to upgrade its firmware to the latest one
Relay OverTemp		<ol style="list-style-type: none"> 1. when it shows this error, normally the charger will reduce the charging current automatically. Try to lower the charging current and then start charging again.
INT OverTemp		<ol style="list-style-type: none"> 1. check if the input cables are connected properly or not 2. check if the diameter of the input cable is correct 3. try to re-install the input cables
RelayError		<ol style="list-style-type: none"> 1. Check if the issue shows all the time even after powering off the charger. If yes, there is something wrong with the relay. Please replace a new PCBA. 2. If the issue is randomly there, try to upgrade its firmware to the latest one.
PhaseError		<ol style="list-style-type: none"> 1. Check if the input cables, L N PE, are correctly connected.
LeakError		<ol style="list-style-type: none"> 1. Power off the charger and power it on. 2. If the issue is still there, try to charge a different EV. 3. if the issue is gone when charge another EV, the issue is related to the EV 4. If the issue is randomly there, try to

		upgrade its firmware to the latest one
MeterError	Metererror means there is something wrong with the communication between the meter and the mainboard. So the issue may exist in the meter, mainboard or the cable.	<ol style="list-style-type: none"> check if the meter is on after the charger is powered on. If the meter is not on, replace the meter. if the meter is on, power off the charger, and unplug the meter cable from mainboard and plug it back to check if the issue is gone. replace the meter or mainboard to check if the issue is gone. (in most cases, replace the meter can solve the issue)
CableRCError		<ol style="list-style-type: none"> The cable is related to the RC resistance of the charger. Please try a different charging cable.
Lock Error		<ol style="list-style-type: none"> unplug the charging cable and re-plug it properly. if the issue is still there, check if there is something wrong with the lock in the socket. Power off the charger and on, and check if the lock will check itself.
GND Warn		<ol style="list-style-type: none"> Check if the PE cable of the charger is connected properly and correctly.
Conct Err	There is something wrong with the communication between the screen and mainboard.	<ol style="list-style-type: none"> reboot the charger to check if the issue is gone re-upgrade the mainboard firmware.
RelayDerate	The relay derate is a kind of protection mechanism. When the temperature of the mainboard goes high, the charging current will reduce gradually.	
TampAlrm	Power off the charger and wait for 10 mins to power it on. After that, check if the issue is gone.	
Elect_err	When the error happens, please upgrade the charger to the latest one. The previous old firmware has this bug. The new firmware has solved it.	

NG Card	NG card means the RFID card is the invalid one. Check if the card is registered or not.	
Card In Use	It means the card is used to start charging already and the charger has not finished yet.	
Meter PhaseError	Check if the L and N cable are connected correctly.	

Note: If the above problems cannot be resolved, contact your dealer.

12.2. Maintenance

Charging stations generally do not require daily or periodic maintenance.

Cleaning the charging station

Use an air compressor, a soft dry cloth or soft-bristled brush to clean the charging station. Do not use water, corrosive chemical substances or aggressive detergents. Disconnect the AC power of the device before cleaning.

13. Dismantling and disposal

The packaging materials are compatible with the environment and can be recycled. Therefore, they can be disposed of in special recycling containers in accordance with the local waste disposal regulations. However, the charger cannot be disposed of as household waste, but must be treated as special waste. It must be disposed of at facilities authorised to dispose of electrical and electronic goods. For more detailed information on the disposal and recycling of this product, please contact the local competent office, waste disposal service or the retailer where you purchased the charger.

1) Uninstalling

- Disconnect the charging station from the AC network
- Remove the AC terminals
- Remove any communication connections
- Unscrew the fixing screws and remove from the metal part or support

2) Packaging

If possible, pack the charging station in its original packaging.

3) Storage

Store the charging station in a dry place where the ambient temperature is between -25°C and +60°C.

4) Disposal

At the end of its life, dispose of the charging station and packaging materials in places that can manage and recycle electrical equipment safely.



14. Warranty

Zucchetti Centro Sistemi SpA provides a warranty of 2 years from the date of installation of the charging station, subject to registration on the website

<https://www.zcsazzurro.com/it/estensione-garanzia>. During the warranty period, Zucchetti Centro Sistemi S.p.A. guarantees the normal operation of the charging station.

If the device is defective or faulty during the warranty period, contact your installer or supplier. If the fault falls within the responsibility of the manufacturer, Zucchetti Centro Sistemi S.p.A. will provide service and maintenance free of charge.

Warranty exclusions:

- Use of the charging station for any other use other than the intended one.
- Defective or faulty design or installation of the system.
- Improper use of the device.
- Incorrect configuration of the outer protections.
- Unauthorised modifications to the device.
- Damage caused by external factors or force majeure (e.g. lightning, power surges, bad weather, fire, earthquakes, tsunamis, etc.)



THE INVERTER THAT LOOKS AT THE FUTURE

zcsazzurro.com



Zucchetti Centro Sistemi S.p.A.
Green Innovation Division
Palazzo dell'Innovazione - Via Lungarno, 167
52028 Terranuova Bracciolini - Arezzo, Italy
zcscompany.com

